

# QuickReader™



**Manual #: 02CO034**

## Installation and Operations Manual

Part Number: **02CO034**  
Printed: **01/00**  
Revision Level: **QR = XX.15**

**Copyright by COMPSEE**

### **Warning**

Changes or modifications to this unit not expressly approved by the party responsible for compliance could void the user's authority to operate the equipment.

### **Notes**

This equipment has been tested and found to comply with the limits for Class A digital device, pursuant to Part 15 of the FCC Rules. These limits are designed to provide reasonable protection against harmful interference when the equipment is operated in a commercial environment. This equipment generates, uses and can radiate radio frequency energy and, if not installed and used in accordance with the instruction manual, may cause harmful interference to radio communications. Operation of this equipment in a residential area is likely to cause harmful interference in which case the user will be required to correct the interference at his own expense.

## QUICK START

The following Quick Start Installation procedure will handle 95% of the keyboard wedge installation. If your cabling and hook-up do not conform to the instructions below, please consult the Programming Manual.

### INSTALLATION

1. **TURN OFF POWER TO THE TERMINAL TO WHICH THE READER WILL BE CONNECTED.**
2. Locate the "Y" interface cable. Plug the 25 pin male "D" connector of the "Y" cable to 25 pin female connector located on the back panel of the unit.

3. Disconnect the keyboard cable from the keyboard port and plug it into the short leg of the "Y" cable.
4. Plug the long leg of the "Y" cable into the terminal keyboard port.
5. Plug in the scanning device.
6. If an external power supply is required, Plug it into the receptacle located on the back of the unit. Then plug the power supply into a power source.
7. Turn on the power to the terminal.

#### 8. PROGRAM FOR TERMINAL TYPE

**IMPORTANT:** If this is a first time installation, it is NECESSARY\_ to program the unit for use with the connected terminal. Proceed as follows:

- Using the TERMINAL TYPE programming menu, scan the **ENTER** bar code symbol.
  - Scan the two (2) digits on the BAR CODE CHART which corresponds to the two (2) digit code listed for the specific terminal.
  - Scan the **EXIT** bar code symbol.
9. Scan the following bar code to verify communications to the terminal.



#### 10. PROGRAMMING FOR ADDITIONAL PARAMETERS

Use the remaining programming sheets, i.e. GENERAL I, GENERAL II, AUXILARY PORT, SCANNER PORT, INDUSTRIAL CODES, RETAIL CODES, and EDIT to complete the programming.

**EXAMPLE:** Return Key After Each Bar Code

- Scanner Port Menu  
Scan: Enter  
Scan: Postamble
- Bar Code Chart  
Scan: 0D
- Scanner Port Menu  
Scan: Exit

**NOTE:** Each sheet has default parameters associated with it which are indicated by asterisks "\*" on the programming menus.

To assign these DEFAULT parameters,

- scan the ENTER symbol
- scan the DEFAULT symbol
- scan the EXIT symbol

If Default parameters are not desired,

- scan the ENTER symbol
- scan the desired parameter
- scan the letter/digit combination listed on the programming sheet
- scan EXIT

*After the EXIT symbol is scanned, the program information is stored in non-volatile memory and will not have to be programmed again unless changes are desired.*

## Table of Contents

<b>I. Introduction</b>		
Output Options	Keyboard Wedge	7
Input Options	Bar Code	8
	Magnetic Stripe	8
	RS 232	8
Standard Specifications	Dimensions	8
	Current Draw	8
	DC Voltage	8
	Environmental	8
	Electrical	8
	Scanning Speed	8
<b>II. Installing the Reader - Keyboard Wedge</b>		
Installation		9
Connecting the Scanning Device		9
Connecting the Power Supply		10
Connecting the External Audio Device		10
Connecting an RS 232 Device		10
Connecting a Magnetic Stripe Reader		10
Terminal Power Up Sequence		10
Programming For Terminal Type		11
Programming Additional Parameters		11
<b>III. Installing the Reader - POS Terminals</b>		
NCR 280 – Non-Buffered Keyboard		12
NCR 280 – Buffered Keyboard		12
NCR 2151		12
NCR 2152		13
NCR 2154/2155		13
NCR 7052		14
IBM 3653		14
IBM 3683		15
IBM 4683		16
DTS 500		18
TEC M-2300-41		18

<b>V.</b>	<b>Programming the Unit</b>	
	Default All	19
	Bar Code Menus	19
<b>VI</b>	<b>General Program Selections</b>	
	Interface Selection	
	Keyboard Wedge	21
	Serial Output	21
	General Menu I	
	Beeper Volume	21
	Input Inhibit	22
	Keyboard Type	22
	Intercharacter Delay	22
	Interfunction Delay	22
	General Menu II	
	Magnetic Track/Auxiliary Port	23
	Buffering	23
	Scale Solicit Record	23
	Switches	
	Output Edited Records Only	24
	IBM 3683 – “0” vs “00” Key	24
	Wyse Turbo Mode	24
	Code 39 & I 2 of 5 Traditional	24
	Algorithms	
	NCR 2152 OCIA	24
	Decimal Coded ASCII	24
	Laser with Marker Beam	24
<b>VII.</b>	<b>Scanner Port Selections</b>	
	Preamble & Postamble	25
	Laser Redundancy	25
	Function Codes	25
	Code Identification	25
<b>VIII.</b>	<b>Auxiliary Port Selections</b>	
	Preamble & Postamble	26
	Record Terminator	26
	Parity	27
	Baud Rate	27
	AUX Port Protocol	27
	Function Codes	27

<b>IX.</b>	<b>Bar Code Selections</b>	
	Codabar	28
	Code 3 of 9	28
	Interleaved 2 of 5	28
	Industrial 2 of 5	28
	Code 11	29
	Code 93	29
	Code 128	29
	Plessey	29
	UPC	29
	EAN	29
<b>X.</b>	<b>Edit Programming</b>	30
<b>XII.</b>	<b>Status Check</b>	
	General/Serial/Scanner	46
	Bar Code Configuration	47
	Edit Status	48
<b>v</b>	<b>Appendices</b>	
	A. Interfaces	49
	B. Beep Sequences	57
	C. Key Code Charts	58
	D. Keyboard Function Records	61
	E. RS 232 Auxiliary Port Specifications	77
	F. RS 232 Data Transfer Definitions	78
	G. Input Inhibit Considerations	84
	H. Service and Repair	89
	I. Limited Warranty Terms	90
<b>v</b>	<b>Figure Listing</b>	
	Keyboard Interface - Wedge	7
	RS 232 Interface - Dual Port	7
	IBM 3180 - 1/2 Input Inhibit Installation	85
	IBM 3179-2 Input Inhibit Installation	86
	IBM 3196 Input Inhibit Installation	87
	IBM 3481/3486 Input Inhibit Installation	88

## I. INTRODUCTION

The decode/interface units are designed to be used with terminals provided by most of the major terminals manufacturers.

- **Output Options**

**Keyboard Interface:** The unit plugs in easily between the keyboard and the terminal. Data passed through the unit appears to the terminal as if it had been keyed in by an operator.

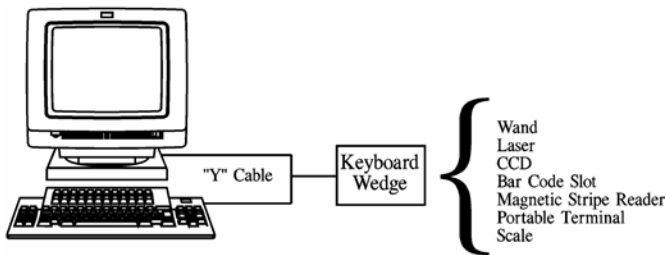

- **Input Options**

For bar code reading, a variety of input devices can be ordered that include light pens, slot readers, moving beam or fixed beam readers. With these devices, the unit is able to scan low, medium, and high density bar codes. The ability to autodiscriminate between most popular bar code symbologies is standard.

Code 3 of 9  
UPC/EAN  
Plessey

Codabar  
Code 128

Interleaved 2 of 5  
Code 93

Industrial 2 of 5  
Code 11

The Auxiliary port can be used to input data from either an external RS 232 device or a magnetic stripe reader. It can also be used as an output port to send ASCII data on a single RS 232 line.

**Magnetic Stripe Input** – The unit can be ordered with a detached magnetic stripe reader to read tracks 1, 2 or a combination of 1 and 2.

**RS 232 Input** - ASCII data from an external reader, a scale or a portable terminal can be transmitted through the RS 232 Input Port.

**RS 232 Output** – Bar code data read via an attached scanning device can be decoded and transmitted out as ASCII data via a single RS 232 Line.

Simple user programming guarantees that data passing through the unit will appear to the software as if it had been keyed in by the operator.

The use of preamble/postamble, embedded keyboard function codes or keyboard function records allows for the operation of the terminal without manual entry from the keyboard.

Changing code parameters or disabling certain codes is accomplished by either using the bar code programming menu. The units non-volatile memory stores the user program selections.

- **Standard Specifications**

- **Dimensions**

- Length 5.75 inches
    - Width 6.50 inches
    - Height 1.25 inches (2.25 inches with magnetic stripe reader)
    - Weight 16 oz - Approximate weight without cable  
24 oz (with magnetic stripe reader)

- **Current Draw**

- 105 mA Models 2000, 2100, 2200, 2300, 3100
    - 145 mA Model 3000

- **DC Voltage**

- Power source shall meet the equipment requirements for reinforced insulation according to EN 60 950:1988 (SELV)

- **Stromversorgung**

- 80 mA at 5 V, 68 mA at 12V
    - Gleichspannung soannungsquelle muss den Isolationvorschriften EN 60 950/1988 entsprechen

- **Environmental**

- Operating Temperature: +5°C to +40°C
    - Storage Temperature: -20°C to +65°C
    - Relative Humidity: 0% to 95% non-condensing

- **Electrical**

- Power is normally consumed from the terminal. No auxiliary power supply is required. Exceptions are noted in Appendix A.
    - RS 232 Interface - The auxiliary power supply is required.

- **Scanning Speed**

- Scans at 3 to 45 inches per second on standard density bar codes. Its speed range varies with code choice and density.



## II. INSTALLING THE READER - NON-POS KEYBOARD WEDGE

Installation of the reader should be completed by a person familiar with installing and connecting computer systems and cabling.

### 1) INSTALLATION

1. TURN OFF POWER TO THE TERMINAL TO WHICH THE READER WILL BE CONNECTED.
2. Locate the "Y" interface cable and verify that it is the correct cable for the terminal being used.
3. Plug the 25 pin male "D" connector of the "Y" cable to 25 pin female connector located on the back panel of the unit.
4. Unplug the keyboard from the terminal and re-plug the keyboard into the leg (short leg) of the "Y" cable that mates with it.
5. Plug the remaining leg (long leg) of the "Y" cable into the terminal where the keyboard was connected.
6. Arrange the fully connected unit so that all cables run fully and smoothly.

### 2) CONNECTING THE SCANNING DEVICE

Plug the scanning device into the appropriate FRONT panel connector. Note that there are two 9 pin "D" connectors on the FRONT panel. One labeled "LIGHT PEN" and the other "12V LASER".

The Light Pen connection is for light pens, slot and wand emulation devices. The 12V Laser connection is for any 5 or 12 Volt device that is trigger activated and outputs a laser emulation signal.

#### *Internal & External Settings for a 5 or 12 Volt Input Device attached to the Laser Port.*

5 Volt: Internal Switch 1 = Over 2 Pins towards the outside of the board.

12 Volt: Internal Switch 1 = Over 2 Pins towards the inside of the board.

Power Supply Required

Internal Jumper	Dip Switch # 2	=	Pin 4 Power	Pin 9 Power	Power Supply
5 Volt	Down	=	5 Volt	5 Volt	--
5 Volt	Up	=	Nothing	5 Volt	--
12 Volt	Down	=	5 Volt	12 Volt	Required
12 Volt	Up	=	Nothing	12 Volt	Required

### 3) CONNECTING THE POWER SUPPLY

An external power supply is required if a 12 Volt Input device is used or the reader is connected to a terminal that required a power supply regardless of the input device. Reference Appendix A or the Genealogy Chart for the unit. If required, an **external power supply must always be used.**

Plug the external power supply into the receptacle located on the back of the unit. Then plug the power supply into a power source.

12 Volt Supply - 12 Volt Input Device Only

5 Volt Supply - 5 Volt Input Device or terminals requiring an external power supply.

### 4) CONNECTING AN RS 232 DEVICE

If an auxiliary RS 232 input device is to be used, plug the 6 pin modular connector of the auxiliary port cable specified at the time of order into the 6 pin modular receptacle located on the FRONT panel of the unit (AUX). Connect the other end of the RS 232 cable into the output port of the RS 232 input device.

### 5) CONNECTING AN EXTERNAL AUDIO DEVICE

If an external audio device is to be used, plug the connector into the EXT AUDIO receptacle located on the FRONT panel. The beeper tone that is output will now be output from the unit and also from emitted through the EXT AUDIO port.

If an external audio device is being used and you wish for the tone to only be emitted through the EXT AUDIO port, the left most dip switch (closest to the outside edge), on the back of the unit must be in an UP position.

### 6) CONNECTING A MAGNETIC STRIPE READER

If a Magnetic Stripe Reader is to be used, plug the modular connector of the magnetic stripe reader into the modular receptacle located on the BACK panel of the unit.

Any changes or additions desired for the Magnetic Stripe output must be programmed via the Edit Parameters.

### 7) TERMINAL POWER UP SEQUENCE

Turn ON the power to the terminal. After approximately 5 seconds the unit will beep twice. This delay is intentional and occurs so that the terminal - keyboard power on reset routines have time to complete.

## 8) PROGRAMMING FOR TERMINAL TYPE

**IMPORTANT:** If this is a first time installation, it is **NECESSARY** to program the unit for use with the connected terminal.

- Using the **TERMINAL TYPE** programming menu, scan the **ENTER** bar code symbol.
- Scan the two (2) digits on the **BAR CODE CHART** which correspond to the two (2) digit code listed for the specific terminal.
- Scan the **EXIT** bar code symbol.

**NOTE:**

After the **EXIT** symbol has been scanned, the terminal type information is stored in non-volatile memory and will not have to be programmed again unless the unit is to be connected to another terminal.

## 9) PROGRAMMING FOR ADDITIONAL PARAMETERS

Use the remaining programming sheets, i.e. **GENERAL I**, **GENERAL II**, **AUXILIARY PORT**, **SCANNER PORT**, **INDUSTRIAL CODES**, **RETAIL CODES** and **EDIT** to complete the programming.

**DEFAULT:** Each sheet has default parameters associated with it which are indicated by asterisks "\*" on the programming menus.

*To assign these DEFAULT parameters,*

1. scan the **ENTER** symbol
2. scan the **DEFAULT** symbol
3. scan the **EXIT** symbol

*If Default parameters are not desired,*

1. scan the **ENTER** symbol
2. scan the desired parameter
3. scan the letter/digit combination listed on the programming sheet
4. scan **EXIT**

*After the EXIT symbol is scanned, the program information is stored in non-volatile memory and will not have to be programmed again unless changes are desired.*

**INSTALLATION IS NOW COMPLETE**

### III. INSTALLING THE READER - POS TERMINALS

Installation of the reader should be completed by a technician or programmer familiar with installing and connecting systems and cabling.

- **NCR 280 - NONBUFFERED KEYBOARD**

1. Be sure the NCR 280 terminal is powered down. Remove the top cover from the terminal.
2. Locate connector M01-01 on the keyboard. Remove this cable.
3. Facing the front of the terminal, position cable # 5169-A (printed circuit board) with the component side UP and P1 to the left. Install the circuit side connector to the keyboard.
4. Install connector M01-01 to P1 on PCB # 5169-A.
5. Feed the narrow end of cable # 5169-B through a convenient slot in the rear of the terminal top cover. You may find it necessary to cut away a portion of the inside of the grill.
6. Continue to feed the narrow end of cable # 5169-B through the round hole in the terminal buffer plate which is behind the speaker. Connect this to P2 on PCB # 5169-A.
7. Feed the grounding strap of cable # 5169B under PCB # 5169A, around the top of the keyboard assembly and attach to the chassis grounding screw (with existing systems chassis ground) at the right hand side of the terminal.
8. Reinstall the terminal top cover.
9. Connect the Male DB 25 pin connector on the end of cable # 5169-B to the back of the unit.
10. Program for Terminal Type 52.
11. For the installation of input devices, RS 232 devices and power supplies, refer to Section 2.

- **NCR 280 - BUFFERED KEYBOARD**

1. Be sure the NCR 280 terminal is powered down. Remove the top cover from the terminal.
2. Locate the smaller printed circuit board that is under the main keyboard printed circuit board. Remove the connector on the left.
3. Install cable # 5169-B between the terminal connector and the terminal keyboard (small printed circuit board). **NOTE:** It may be necessary to remove the keyboard from the terminal to connect this.
4. Feed the narrow end of cable # 5169-B through a convenient slot in the rear of the terminal top cover. You may find it necessary to cut away a portion of the inside of the grill.
5. Continue to feed the narrow end of cable #5169-B through the round hole in the terminal buffel plate which is behind the speaker. Connect this to P2 on PCB # 5169-A.
6. Feed the grounding strap of cable #5169B under PCB # 5169A, around the top of the keyboard assembly and attach to the chassis grounding screw (with existing systems chassis ground) at the right hand side of the terminal.
7. Reinstall the terminal top cover.
8. Connect the Male DB 25 pin connector on the end of the cable # 5169-B to the back of the unit.
9. Program for Terminal Type 52.
10. For the installation of input devices, RS 232 devices and power supplies, refer to Section 2.

- **NCR 2151**

1. Be sure the NCR 2151 terminal is powered down. Facing the front of the terminal, remove the lower front panel by turning the two (2) fastener screws one quarter (1/4) turn counter- clockwise and then slide the cover straight out.
2. Locate any cables that may be attached to the front of the two printed circuit boards (PCB's). Note the orientation of the cables and remove each one from the PCB's by gently pulling them straight out.
3. Unlatch the PCB slide mechanism by pushing the tab of each slide (located between the upper and lower PCB), toward the outside of the terminal and pulling the slide assembly straight out until the slides stop (about 6").
4. Unlatch the two PCB's from the slides by pushing the tab of each slide (located on either side of the lower PCB) toward the outside of the terminal and pulling both PCB's straight out until the rear of the PCB's are even with the front of the terminal (about 6").

5. Locate I/O cable P7 (located at the rear left corner of the top PCB). First note the orientation of the cable and then slide the cable off the connector.
6. Connect J7 (located on the bottom of the PCB - DCF 5151) to the P7 connector (located at the left rear of the top PCB). Carefully align the connector pins before sliding the DCF 5151 forward on to the PCB connector.
7. Connect the I/O cable P7 (removed in step 5 above), to the J7A connector (located on the top of the PCB# 5151). Orient the cable in the same direction as it was when connected to P7 of the PCB.
8. Locate the large 60 pin connector at the center/left of the top PCB. Holding the PCB/s steady, SLOWLY pull the long lever of the connector STRAIGHT out (about 1/2").
9. Place cable plug T1 (the end of the short cable attached to the PCB - # 5151), all the way to the front of the 60 pin PCB connector.
10. SLOWLY push the long lever of the connector STRAIGHT in.
11. Connect the AMP Housing end of Cable 5156/84 the J1 connector on PCB - # 5151.
12. Make sure that all cable connections are secure. SLOWLY slide the PCB/slide assembly back into the terminal until all latches are secure.
13. Feed the grounding strap of cable # 5156 to the front of the terminal and attach to the chassis grounding stud on the left front.
14. Reconnect all cables removed in step 2 above. Reinstall the front cover of the terminal, threading the cable (# 5156/84) down the front left side of the terminal and the bottom between the front cover and terminal chassis.
15. Connect the Male DB 25 pin connector on the end of the cable (# 5156/84) to the back of the reader.
16. Program for Terminal Type 36.
17. For the installation of input devices, RS 232 devices and power supplies, refer to Section 2.

- **NCR 2152**

1. Be sure the NCR 2152 terminal is powered down. Facing the front of the terminal, screw inward the two (2) large pan head screws that fasten the top half of the terminal to the bottom half.
2. Lift up the top half of the terminal from the front, (the terminal is hinged at the back). Use the two (2) support rods, located at the left and right sides of the terminals' bottom half to hold up the terminals' top half.
3. Locate the plate covering the printed circuit boards (PCBs). Loosen (DO NOT REMOVE) any screws holding down the plate. Slide the plate to the left, lift the plate up over the screw heads, and remove. This exposes the component side of the top PCB.
4. Find the keyboard interface connector at the left rear of the lower (larger) PCB. Depending on the model of the terminal, this is either connector J12 or J8. Note the connectors' orientation for future reference.
5. Remove the keyboard interface connector located above and connect it to J12A (located on PCB - # 5152).
6. Connect P12 of DCF 5152 to the mating connector (J12 or J8) on the PCB.
7. Feed the grounding strap of Cable # 5157 above the terminal power supply shield and attach it to the screw on the back left (with existing systems chassis ground).
8. At the inside left rear of the terminal base (at the back of the terminal), locate the two (2) wing nuts holding the cable strain relief bracket in place. Loosen the wing nuts enough to feed the 26 pin connector end of Cable # 5157 upward through the opening on the left side of the terminals rear panel, and through the cable strain relief.
9. Now connect the 26 pin connector of # 5157 to J1 of # DCF 5152 and secure the cable using the wing nuts and strain relief plate loosened above.
10. Replace the plate over the PCB's and return the hood support rods and hood to their original positions. Back out the two (2) screws at either side of the terminal top to secure the top to the terminal bottom.
11. Connect the Male DB 25 pin connector on the end of the Cable # 5157 to the back of the unit.
12. Program for Terminal Type 37.
13. For the installation of input devices, RS 232 devices and power supplies, refer to Section 2.

- **NCR 2154/2155**
  1. Be sure the NCR 2154/2155 terminal is powered down.
  2. Remove the keyboard assembly by locating the tabs which are immediately underneath the front of the keyboard. Push the tabs inward. Lift the keyboard up and pull out.
  3. Locate the 6 pin phone plug inserted in the keyboard printed circuit board (PCB). Remove this plug and connect it to the 6 pin phone socket of the 5133 cable.
  4. Connect the 6 pin phone plug on the 5133 cable into the keyboard PCB.
  5. Route the 5133 cable past the ON/OFF switch of the terminal and up through the power switch slot in the keyboard assembly.
  6. Reinstall the keyboard assembly.
  7. Program for Terminal Type 39.
  8. For the installation of input devices, RS 232 devices and power supplies, refer to Section 2.
  
- **NCR 7052**
  1. Be sure the NCR 7052 terminal is powered down.
  2. Remove the back panel from the NCR 7052.
  3. Disconnect the keyboard cable and attach it to the female end of Cable # 5183. Attach the male end of Cable # 5183 to the keyboard connection inside the back of the 7052.
  4. Connect the Male DB 25 pin connector on the end of Cable # 5183 to the back of the unit.
  5. Plug the Power Supply into the connector on the back of the unit.
  6. A Power Supply is required. A standard power supply can be used if only a 5 volt input device is attached to the reader. If a 12 Volt input device is being used, the laser power supply must be also be used.
  7. Program for Terminal Type.

109 Keys =	60
30 Keys =	61
50 Keys =	61
  8. For the installation of input devices, RS 232 devices and power supplies, refer to Section 2.
  
- **IBM 3653**
  1. Open Terminal Printer Access Door.
  2. Open Journal Access Door.
  3. To remove the right side cover from the terminal, loosen the large screws at the front and rear of the panel, then pull back and out.
  4. Remove the lamp display/keyboard cover by loosening screws at the top corners of the cover.
  5. Lift the rear of the cover and slide it back to disengage slide locks located at the lower corners of the keyboard cover.
  6. Position cover at front of terminal without straining the wires going to the lamp display.
  7. Locate the keyboard connector at the left of the keyboard. Note the orientation of this connector for future reference.
  8. Remove the connectors black "C" clip retainer and then connector from the keyboard.
  9. Connect the keyboard cable to PCB 5162-A. **NOTE:** The wire side of the keyboard connector pins go to the pins nearest the outside edge of cable # 5162-A.
  10. Install PCB # 5162-2 on to the keyboard connector and replace "C" clip retainer.
  11. Feed the small connector end of # 5162-B/5177B (Cable) through the bottom rear (right side) access hole and route the cable up to J1 of PCB # 5162-A.
  12. Attach the pig-tail grounding connector to bolt located on the left side of the terminal, in back of the speaker. The bolt indicated is the only one of four in the area without an extra ground connection on it.
  13. Using a tie wrap, strain relief the cable as it exits the unit at the back.
  14. Make certain that all cables are not causing an obstruction to any moving parts or covers.
  15. Replace the Lamp Display/Keyboard cover and the right side cover.
  16. Connect the Male DB 25 pin connector on the end of the cable # 5162/5177 to the back of the unit.
  17. Program for Terminal Type 44.
  18. For the installation of input devices, RS 232 devices and power supplies, refer to Section 2.

19. **Power OFF & ON the Terminal after the completion of programming.**
20. If the unit has previously been connected to an IBM 4683 Terminal, it will be necessary to "Default" the programming menus that pertain to Industrial Codes.

- **IBM 3683**

1. Remove the top cover of the terminal by disengaging the locks located in the slot between the upper and lower terminal housing near the front of the terminal on the left and right sides.
2. Remove the keyboard by lifting straight up.
3. Remove the entire printer assembly
4. Move forward the black locking lever on either side located at the base of the terminal near the front.
5. Remove the ground strap from the right side of the front PCB.
6. Lift the entire printer assembly straight up and out.  
**WARNING:** Before performing the next step, note the orientation of the keyboard connector.
7. Remove the keyboard connector by flexing the lock tabs holding the connector in place.
8. Slip the plastic card guide from the top of the keyboard connector (J16) and place it on top of Cable # 5161-C (J16A).
9. Feed the keyboard connector through the terminal cover hole, (under the printer support plate toward the back of the terminal).
10. Attach J16 to P16 of cable # 5161-A. Attach cable # 5161-A to the bottom plate of the terminal with the velcro strips.
11. Feed the J2 end of cable # 5161-C through the terminal (follow the same route as Step 6). Attach J2 to P2.
12. Attach J16A to the cover by flexing the locktabs.
13. ***Make sure the orientation is the same as when J16 was removed.***
14. Remove the rear access panel (wedge) by sliding straight out.
15. Remove the fan shroud by pulling straight out.
16. Feed J1 of cable # 5161-B through the rear cover and between the fan and the card cage. Attach J1 to P1 of cable # 5161-A.
17. Use tie wraps to provide strain relief to the cable along its path to the rear exit of the terminal.
18. Attach the grounding strap from Cable # 5161B to any male quick disconnect on chassis ground plane at the rear of the terminal.
19. Replace
  - a) Fan Shroud
  - b) Rear Access Panel
  - c) Printer Assembly
  - d) Keyboard
  - e) Top Cover
20. Connect the Male DB 25 pin connector on the end of the cable the back of the unit.
21. Program for Terminal Type:

48 Key =	43
35 Key =	51
22. For the installation of input devices, RS 232 devices and power supplies, refer to Section 2.
23. **Power OFF & ON the Terminal after the completion of programming.**
24. If the unit has previously been connected to an IBM 4683 Terminal, it will be necessary to "Default" the programming menus that pertain to Industrial Codes.

- **IBM 4683**

When interfaced to the IBM 4683, the unit is not considered a wedge. The unit emulates the functions of the IBM 1520 Hand-Held Scanner Model A02 and/or IBM Dual Track Magnetic Stripe Reader attached to the 5B port of the 4683.

**Possible Wedge to IBM 4683 Interface Configurations are:**

- Wedge attached to Port 5B using Cable 5167.
- Wedge and Magnetic Stripe Reader attached to Port 5B using Cable 5167.
- Wedge and IBM Dual Track Magnetic Stripe Reader attached to Port 5B using the IBM 5B Port "Y" Cable (IBM Part Number 25F6266) and Cable 5167.
- Wedge attached to Port 17 with Cable 5119 and IBM Dual Track Magnetic Stripe Reader attached to Port 5B. This is the same configuration as above, with the exception of the "Y" cable.

**NOTE:** These configurations may be used only if another IBM device is needed that required a Port 17 attachment.

**Installation Procedures:**

1. Be sure the IBM 4683 terminal is powered down.
2. Plug into the 5B Port Cable # 5167 or plug into Port 17 Cable # 5119.
3. Program for Terminal Type 45.

**Wedge to IBM 4683 considerations:**

- The unit when connected to the IBM 4683, must be powered up, programmed for Terminal ID, and then powered off and on for proper operation. This sequence is only necessary upon installation of a unit that has not previously been programmed for the proper ID.
- Preambles and Postambles may not be used. If similar additions are necessary to the output record, CAPE should be used.
- Since this interface is not considered a wedge, the following parameters will not apply:
  - Keyboard Functions
  - Intercharacter Delays
  - Interfunction Delays
- Even though the Wedge emulates a Dual Track Magnetic Stripe Reader, it can be configured with only a single track reader (Track 1 or 2). The 4683 can process either single or dual track input as if it came from a dual track reader. The data format from the Wedge is the same as from the dual track reader.
- Buffering of data records is automatically disabled when ID 45 is selected. This prevents a possible buffer overflow at the 4683.
- All featured bar code symbologies can be read by the wedge, but symbologies other than the following along with any Auxiliary Port data (RS 232) will be identified to the 4683 as Code 3 of 9 data.

UPC-A	EAN - 8
UPC-E	EAN - 13
CODE 3 OF 9	INTERLEAVED 2 OF 5
- CAPE editing may be used on data from the magnetic card reader attached to the wedge if the Start and Stop Sentinel are not edited from the card data. The 4683 requires the Start and Stop Sentinels to format the data.
- It is recommended that any time the unit is moved from one terminal to another, that the parameters be defaulted and the unit reprogrammed.



### IBM 4680 Systems Controller Considerations

- At the systems controller, from the SYSTEM MAIN MENU, select the following from the different menus.
  - Select # 4 - Installation and Update Aids
  - Select # 1 - Change Configuration Data
  - Select # 1 - Terminal Configuration
  - Select # 1 - Terminal Device Groups
  - Select # 1 - Define a Terminal Device Groupor
  - Select # 2 - Change/Display a Terminal Device Group
- At this point, the system will ask for the name of the terminal device group being processed.
- Enter a group name. Example: ADXGRP09
- A line drawing of the back of the 4683 POS will now be displayed. The operator is prompted to type an "X" in each box that has a cable connected to it. Place an "X" in the box designated as "5B". **NOTE:** If the unit uses Cable 5119 for the Port 17 interface, place an "X" in the box designated "5B", NOT "17".
- Type the information to describe the device in Port "5B".
  - Device Type 1 = Wedge Only
  - Device Type 4 = Wedge with Magnetic Stripe Reader, including IBM Magnetic Stripe Reader
- The scanner good read "ENABLE TONE" prompt has no effect on the unit since the beeper for unit is controlled through the menus.
- Desired Label Type. Place an "X" in the box relating to the type of symbology to be read. If a symbology is to be read by the unit, but is not listed by the 4683, put an "X" in the box marked Code 39.
- The selections for Magnetic Stripe Reader must be answered if Device Type 4 was selected above.
  - Model 1 = Wedge Magnetic Stripe Reader
- Select "Track 2" regardless of the type of magnetic stripe reader attached to the wedge.
- Return to the IBM 4680 Store System "CONFIGURATION" menu. Select # 5 = Active Configuration
- From the "ACTIVE CONFIGURATION" menu. Select # 1 = Terminal Configuration
- This completes the changing and activation of the terminal configuration necessary to accommodate the wedge.
- Return to the "INSTALLATION AND UPDATE AIDS" menu. Select # 3 = Change Input Sequence Table Data
- Using the "INPUT SEQUENCE TABLE UTILITY", set up the following tables to conform to the bar code and magnetic stripe labels being used in the application.
  - Input State
  - Label Format
  - Modulo Check

### IBM 4683 - Unit Testing

- Unit testing of the wedge and dual magnetic stripe readers may be performed by using the IBM 4680 Store System Problem Determination Guide (IBM # SY27-0316-0).
- Refer to Page 4-70, TEST 4220, to test the scanner portion. Some of the off-line tests within TEST 4220 only apply to the IBM 1520 Scanner Model A02, but all on-line tests apply to the wedge.
- Refer to Page 4-25, TEST 4080, to test the dual magnetic stripe reader portion.

**NOTE:** Only the magnetic stripe reader attached to the wedge may be tested at this time.

- **DTS 500**

1. Be sure the DTS 500 terminal is powered down. Remove the top cover.
2. Remove the keyboard assembly by disconnecting the flat ribbon cable at the keyboard.  
**\*\* NOTE THE ORIENTATION OF THE CABLE \*\***
3. Facing the terminal, position the printed circuit board (PCB) 5185 with the component side up and J1A (the 90 degree connector on the PCB) toward the rear of the terminal. Connect the cable that was removed in step two (2) to J1A in the same orientation as it was connected to the keyboard.
4. Feed the micro-clip and red wire around to the right side of the card cage.
5. Attach the micro-clip to the right most lead of the capacitor C114 (lead marked plus (+) on the terminal interface board. (PCB with DB 25 connector on the right hand edge).
6. Feed the Amp connector end of Cable 5156 up through the terminal's right side cable access and route cable through the terminal. Install on J2 of PCB 5185.
7. Feed the flat ribbon connector T1 of PCB 5185 into position and attach keyboard.
8. Insure that PCB 5185 is positioned so that it does not come into contact with any other circuit boards with the terminal.
9. Reinstall keyboard and covers.
10. Connect the Male DB 25 pin connector on the end of cable 5156 to the back of the unit.
11. Program for Terminal Type 62.
12. For the installation of input devices, RS 232 devices and power supplies, refer to Section 2.

- **TEC M-2300-41**

1. Be sure the TEC M-2300-41 terminal is powered down.
2. Remove the top cover from the terminal.
3. Remove the keyboard assembly by disconnecting the 40 pin ribbon cable on the keyboard and the power cable from the register switch.
4. Feed cable 5156 (26 pin vertical connector) into the rear of the terminal and between the 3rd and 4th printed circuit boards (PCB) from the bottom to the front of the terminal.
5. Connect the cable from the main PCB that was disconnected from the keyboard to the supplied PCB at the connector called "B". Connect cable 5156 to the supplied PCB 26 pin vertical connector.
6. Lay the supplied PCB flat on the main PCB in the terminal so that the bottom of the PCB lays on the 40 pin ribbon cable.
7. Reinstall the keyboard assembly by connecting the free 40 pin ribbon cable (6 1/2" supplied with the PCB) to the keyboard assembly and reconnecting the power cable to the register switch.
8. Make sure all cable connections are secure and reinstall the cover.
9. Connect the Male DB 25 pin connector on the end of cable 5156 to the back of the unit.
10. Program for Terminal Type 39.
11. For the installation of input devices, RS 232 devices and power supplies, refer to Section 2.

#### IV. PROGRAMMING THE UNIT

The unit is pre-programmed with standard default parameters that allow you to use it without programming. For customization, you can change any of the parameters by scanning the bar code labels in the programming menus. Once the parameter is selected, it is stored in non-volatile memory, and will not change unless the unit is reprogrammed.

**IMPORTANT:** If this is a first time installation, it is **NECESSARY** to program the unit for use with the connected terminal.

**DEFAULT ALL** - Reference Program Mode Menu. To default the unit, the "Default All Parameters" bar code must be read. This will issue a High-Low beep. Approximately 1 second after this two (2) High beeps will be issued signaling that the unit is now reset to factory defaults. Once Defaulted, the Terminal ID will be set to "01" and all parameters on all of the programming menus, including the edit menu, will reset to their factory setting.

The Bar Code Menus provided with each unit consist of the following pages:

- A. Terminal Selection Menu
- B. General I Menu
- C. General II Menu
- D. Scanner Port Menu
- E. Auxiliary Port Menu
- F. Codes - Industrial Menu
- G. Codes - Retail Menu
- H. Edit Menu
- I. Status Check Menu
- J. Parameter Selection Menu Bar Code

The following beep sequences should be noted when programming the unit.

- 1 HIGH, 1 LOW** = Good Programming Read
- 2 HIGH** = Exit Programming - Good Read
- 1 HIGH, 2 LOW** = Programming Error - Out of Sequence Programming Label

**Example 1:** Select Terminal Type (DEC VT 320 = Terminal Type 15)

1. Using the TERMINAL TYPE programming menu, scan the ENTER bar code symbol.
2. Using the Bar Code Chart, scan a 1, then a 5 under the digits column.
3. Scan the EXIT bar code symbol.

**Example 2:** Select a Scanner Postamble  
"ABC" followed by the TAB key.  
(Codes 41,42,43,09)

1. Using the SCANNER PORT programming menu, scan the ENTER bar code symbol.
2. Scan the Postamble bar code
3. Using the Bar Code Chart, scan a 4,1,4,2,4,3,0,9 using both the alpha and digits columns.
4. Scan the EXIT bar code symbol.

## ***DEFAULT SELECTIONS***

1) ***ALL SELECTIONS***

To default back to the factory set parameters scan the DEFAULT ALL symbol on the Status Programming Menu. After the bar code is scanned, a high-low beep sequence will be emitted from the unit

**Note:** DEFAULT ALL will delete all edits that have been programmed.

2) ***PER MENU PAGE***

To default to the factory set parameters by menu page, scan:

Enter - for the page parameters you wish to default

Default

Exit

## V. GENERAL PROGRAM SELECTIONS

### 1. TERMINAL SELECTIONS

#### a) *INTERFACE SELECTION - KEYBOARD WEDGE*

##### Menu Page = **Terminal Selection**

This parameter programs the unit for the terminal it is attached via the keyboard.

Sequence of operation for programming the terminal selection

- a) Scan "ENTER TERMINAL SELECTION"
  - b) Scan the two (2) digit number corresponding to the terminal desired.
  - c) Example: For an IBM 3180-1 Terminal, Scan a "0" then a "5" on the Bar Code Menu Page.
  - d) Scan "EXIT TERMINAL SELECTION"
- 
- **Single Port RS 232 - Data Output**
    - a) Scan "ENTER TERMINAL SELECTION"
    - b) Single Port RS 232 ID = 31
    - c) Scan "3" then a "1" on the Bar Code Menu Page.
    - d) Scan "EXIT TERMINAL SELECTION"

### 2. GENERAL I MENU

##### Menu Page = **General I**

This menu page is used to program various functions that apply to all input through the unit.

The DEFAULT Selections for the General Menu are indicated on the menu by an asterisk "\*"

<b>BEEPER VOLUME =</b>	7
<b>INPUT INHIBIT CHECK =</b>	OFF
<b>KEYBOARD TYPE =</b>	PRIMARY
<b>INTERCHARACTER DELAY =</b>	00 (NONE)
<b>INTERFUNCTION DELAY =</b>	00 (NONE)

- **Beeper Volume**

The unit will emit a beep after each successful read. This beep can range in volume from 0 (OFF) to 7 (HIGH). The default is 7 (HIGH).

- **Input Inhibit Check**

In most terminal environments, the terminal is often “inhibited” from sending data to the host CPU. This happens after a screen or page of data is sent to the host CPU by the operator activating the “XMIT”, “REC ADV”, or “ENTER” key. Further input from the keyboard is ignored by the terminal as long as input is inhibited by the host.

Reference Appendix A for terminals that allow monitoring of the Input Inhibit line.

Reference Appendix G for terminals that require the installation of leads inside the terminal to monitor input inhibit.

Reference Appendix F for further usage of Input Inhibit during data transmission

- **Keyboard Type**

Most terminals supported by the unit can have one of two styles of keyboards attached to it. Through programming you can change from one type to another.

The types of keyboards are often referred to as:

- ◆ Typewriter versus Data Entry
- ◆ 122 Keys versus 102 Keys
- ◆ No Caps Lock versus Caps Lock
- ◆ Telephone versus Calculator

**NOTE:** Caps Lock on Versus Caps Lock Off

Output of alpha data to the terminal is affected by the ON or OFF state of the CAPS LOCK key. Under default, the unit assumes that CAPS LOCK is OFF and sends the "SHIFT" key prior to the output of alpha data. The alpha data then appears as upper case characters.

However, if the terminal program functions with CAPS LOCK ON, the addition of the "SHIFT" key sends the data to the terminal as lower case alpha characters. If this is the case, the Keyboard Type should be set to Secondary.

- **Intercharacter Delay**

This parameter is used to establish an intercharacter delay time of 10 to 990 milliseconds. The delay will appear after each character is transferred to the terminal screen.

This delay parameter should be specified if you find that the terminal cannot keep up with the speed at which the unit is sending data to the screen, or if the host program is inserting multiple keyboard functions into the data being entered.

- **Interfunction Delay**

This parameter is used to establish an interfunction delay time of 10 to 990 milliseconds. The delay will appear after each keyboard function is transferred to the terminal screen.

This delay parameter should be specified if you find that the terminal cannot keep up with the speed at which the unit is sending data to the screen, or if the host program is inserting multiple keyboard functions into the data being entered.

### 3. GENERAL II MENU

Menu Page = **General II**

The second General Menu is also used to program various functions that apply to input through the unit.

The DEFAULT Selections for the General Menu are indicated on the menu by an asterisk "\*"

<b>MAGNETIC TRACK</b>	= TRACK 2
<b>BUFFERING</b>	= ON
<b>SCALE SOLICIT RECORD</b>	= NONE
<b>SWITCHES</b>	
1) Output Edited Records Only	= OFF
2) IBM 3683 Keyboard Variation	= OFF
3) IBM 3683 Keyboard Variation	= OFF
4) Wyse Turbo Mode	= OFF
5) Code 39 & I 2 of 5 Traditional Algorithms	= OFF
6) NCR 2152 OCIA	= OFF
7) Decimal Coded ASCII	= OFF
8) Laser with Marker Beam	= OFF

- **Magnetic Track / Auxiliary Port**

This parameter is used to establish the use of the Auxiliary Port. The choices are either RS 232 Input from portables or scales, or input from a magnetic stripe reader.

If a magnetic stripe reader is attached, the unit must be programmed to match the output of the reader. The options are:

- RS 232 Input
- Track 1
- Track 2
- Tracks 1 & 2 – 1 Only
- Tracks 1 & 2 - 2 Only
- Tracks 1 & 2 – Both Tracks
- Tracks 1 & 2 – Any Valid Track

- **Buffering**

This parameter is used to set the buffering mode of the unit. This parameter only applies to the data being received from one of the scanner ports.

If the buffer is ON (Default), and the attached terminal is not ready to accept data, the unit will buffer up to 32 entries, maximum of 64 characters per entry.

If the buffer is OFF, the unit will not accept another entry until the record previously read has been transmitted to the attached terminal and the buffer has been cleared.

- **Scale Solicit Record**

Typical usage for this parameter is when for an application requires a scale to be attached to the RS 232 auxiliary port. Most scales require that a record be sent to it prior to initiating the response from the scale.

This parameter is used to set the ASCII character or characters that will be transmitted. The defined character(s) will be held in the units buffer under the Hex 05 Function Code - Referred to as SOLA (Solicit). Whenever the Hex 05 Function Code is programmed into the output record (preamble, postamble, output edit) the solicit record in the buffer will be sent out to the attached scale. Once received, the scale will respond by transmitting the data string containing the weight information back to the wedge.

A maximum of four (4) ASCII characters can be programmed. The default value for this parameter is "NONE".

**Example:**

The scale requires a "P" followed by a "Carriage Return" sent to it prior to it transmitting the weight data out the RS 232 Port.

Program the unit for a Scale Solicit Record of 50, 0D. Whenever the SOLA Function Code (Hex 05) (Postamble or Singular Function Code) is inserted in the data string, the record (Hex 500D) will be transmitted out the RS 232 port to the scale, causing the scale to respond with the transmission of the weight data back to the wedge.

- **Selector Switch 1: Output Edited Records Only**

This parameter is used to establish what input records will be transmitted to the terminal.

If this parameter is ON, only the records that have been defined and edited via the EDIT Program Parameters will be passed through to the terminal.

If this parameter is OFF (Default), all input will be passed through to the terminal. This includes both edited and non-edited records.

- **Selector Switch 2 & 3: IBM 3683 "0" vs "00" Key Position**

The On/Off state of Switches 2 & 3 determine the key position of the "0" versus the "00" key on the IBM 3683 keyboard. Reference Appendix D: IBM 3683 for keyboard layout and program instructions.

- **Selector Switch 4: WYSE Turbo Mode**

For WYSE terminals 160 & 370 (ID's 50,51 & 53), the speed of output to the terminal can be increased by turning Switch 4 ON.

- **Selector Switch 5: Code 39 & I 2 of 5 Traditional Algorithms**

Under default parameters the decode algorithm incorporated in the unit allows for degraded wide to narrow bar and space ratios. If traditional decode algorithms are desired, turn on Switch 5.

- **Selector Switch 6: NCR 2152 OCIA Output**

If ON, Magnetic Stripe will be transmitted to the NCR 2152 OCIA Port and scanned data will be transmitted to the 2152 Keyboard Port.

- **Selector Switch 7: Decimal Coded ASCII**

IF ON, via a CAPE Edit, input data can be selected for output equivalent to Decimal Coded ASCII (DCA).

- **Selector Switch 8: Laser with Marker Beam**

If the Marker Beam option is installed on the attached laser input device, Switch 8 should be turned on. When ON, the unit will delay the start of decode to allow time for the marker beam.



## VII. SCANNER PORT MENU

### Menu Page = **Scanner Port**

This menu page is used to program various functions that apply to input through the Scanner Port.

The DEFAULT Selections for the Scanner Port Menu are indicated on the menu by an asterisk "\*"

**PREAMBLE** = NONE  
**POSTAMBLE** = NONE  
**LASER REDUNDANCY** = OFF  
**FUNCTION CODES** = OFF  
**CODE IDENTIFICATION** = OFF

- **Preamble & Postamble**

The user may specify a Preamble and/or Postamble (maximum of 16 characters each) to precede or follow each code scanned.

Preamble	Scanned Data	Postamble
----------	--------------	-----------

**NOTE:** Embedding the "ENTER", "REC ADV", or "XMIT" keys within the data being transmitted will result in either a portion of, or all of the data following these key functions not be transmitted to the screen.

To prevent loss of data, only use the "ENTER", "REC ADV", or "XMIT" keys as the last character of the Postamble or program in an adequate "Pause" after the function to allow for a new screen to appear.

When programming for a Preamble and/or a Postamble, the Hex representation for each character desired must be entered. Refer to either the Key Code Chart in Appendix C.

**NOTE:** Any programmed Preamble & Postamble will not be included in the output for a record that has been edited. If a Preamble or Postamble is required on an edited record, it must be included in the edit.

- **Laser Redundancy**

When enabled, the unit will require two (2) identical reads of a bar code to be decoded prior to accepting the bar code input and signaling for the light source to be turned off on the input device.

- **Function Codes**

If Keyboard Function Codes (i.e., Field Forward, Xmit, etc.) are embedded within the bar codes that are being read, this feature must be turned ON. See Appendix B for a listing of the keyboard functions and the programmed codes associated with each function.

- **Code Identification**

This parameter programs the unit to precede the transmission of each bar code read with a character that identifies the type of symbology the code was printed in. The symbologies and their identifiers are as follows:

CODABAR	= a	CODE 3 OF 9	= b	UPC-A	= c
EAN	= d	I 2 OF 5	= e	2 OF 5	= f
CODE 128	= j	CODE 11	= h	CODE 93	= I
PLESSEY	= g				

## VIII. AUXILIARY PORT MENU

### Menu Pages – Scanner Port

This menu page is used to program various functions that pertain to input through the RS 232 Auxiliary Port of the unit or to input from the Magnetic Swipe Reader.

The DEFAULT Selections for the Auxiliary Port Menu are: (indicated by an asterisk on the menu)

<b>PREAMBLE</b>	= NONE
<b>POSTAMBLE</b>	= NONE
<b>RECORD TERMINATOR</b>	= "0D"
<b>PARITY</b>	= EVEN
<b>BAUD RATE</b>	= 9600
<b>PROTOCOL</b>	= RECORD
<b>FUNCTION CODES</b>	= OFF

- **Preamble & Postamble (AUX Port Input Only)**

Through programming, the user may specify a Preamble and/or Postamble (maximum of 16 characters each) to precede or follow all data being transmitted that was received from the RS 232 auxiliary port or Dual Serial Input.

Preamble	RS 232 Input Data	Postamble
----------	----------------------	-----------

**NOTE:** Embedding the "ENTER", "REC ADV", or "XMIT" keys within the data being transmitted will result in either a portion of, or all of the data following the these key functions not be transmitted to the screen.

To prevent loss of data, only use the "ENTER", "REC ADV", or "XMIT" keys as the last character of the Postamble or program in an adequate "Pause" after the function to allow for a new screen to appear.

When programming for a Preamble and/or a Postamble, the Hex representation for each character desired must be entered. Refer to either the Key Code Chart in Appendix C.

**NOTE:** Any programmed Preamble & Postamble will not be included in the output for a record that has been edited. If a Preamble or Postamble is required on an edited record, it must be included in the edit.

- **Record Terminator (AUX Port Input Only)**

Each data record that the unit receives from the Auxiliary Port is held in a buffer until a Record Terminator is received. Once received, the unit will discard the Record Terminator, process the data received and then transmit the data.

One character must be programmed as the Record Terminator. Any of the ASCII characters may be used as a Record Terminator. *The Record Terminator will NOT appear on the screen.* The only function of the Record Terminator is for usage by the unit to signal the end of a data record.

When programming for a Record Terminator, the Hex representation for each character desired must be entered. Refer to the Key Code Chart in Appendix C.

If the last character of the data does not match the Record Terminator specified, no data will be sent to the screen.

- **Parity**

Program Parity Checking for serial transmission compatibility with the external device connected to the Aux Port or to the host system if data output is RS 232 Single. If Parity compatibility is not achieved, a series of beeps will be emitted.

Selections include:

MARK = A                      SPACE = B  
EVEN = C                      ODD = D                      NONE = E

- **Baud Rate**

Program the Baud Rate for serial transmission compatibility with the external device connected to the Aux Port or to the host system if data output is RS 232 Single. If the Baud Rate compatibility is not achieved, a series of beeps will be emitted.

Selections include:

300 = A  
1200 = B  
9600 = C

- **RS 232 Input Protocol**

If multiple data records are being sent through the unit to the screen from an external portable reader/computer, a Data Transfer Protocol must be set. If a Data Transfer Protocol is not set, the unit will only receive data on a record-to-record basis.

A detailed explanation of each Protocol can be found in Appendix F.

Through programming you can change the Protocol to one of the following:

RECORD = A                      SOLICIT / XON = B  
BURST = C                      ACK/NAK = D

- **Function Codes**

If Keyboard Function Codes (i.e., TAB, ENTER, etc.) are embedded within the data being received from the RS 232 Port and are to be transmitted as keyboard functions, this feature must be turned ON.

If OFF, keyboard function characters received by the unit will be ignored.

## IX. BAR CODE SELECTIONS

### Menu Pages - Code Selection Industrial & Retail

These menu pages are used to enable or disable the various bar code symbologies that the unit is able to decode. They are also used to set the different variables within each code symbology.

Upon DEFAULT, the unit is able to auto-discriminate between all codes. The DEFAULT variables for each code are indicated by an asterisk on the menu.

To change any of the variables, you must:

- 1) Enter Industrial/Retail Code Selections
- 2) Scan the symbology you wish to change
- 3) Scan the Alpha for the variable you wish to change
- 4) Scan the selection within the variable.
- 5) Either select another variable, select another symbology or Exit Code Selections.

- **Codabar**

<u>Variables</u>	<u>Selections</u>	<u>Default</u>
ENABLE	ON or OFF	ON
MINIMUM LENGTH	00 -> 64	00
MAXIMUM LENGTH	00 -> 64	64
START/STOP XMIT	ON or OFF	OFF
CONCATENATE	ON or OFF	OFF

- **Code 3 of 9**

<u>Variables</u>	<u>Selections</u>	<u>Default</u>
ENABLE	ON or OFF	ON
MINIMUM LENGTH	00 -> 64	00
MAXIMUM LENGTH	00 -> 64	64
START/STOP XMIT	ON or OFF	OFF
FULL ASCII	ON or OFF	ON
CHECK DIGIT	ON or OFF	OFF
CHECK DIGIT XMIT	ON or OFF	OFF
APPEND	ON or OFF	OFF

- **Interleaved 2 of 5**

<u>Variables</u>	<u>Selections</u>	<u>Default</u>
ENABLE	ON or OFF	ON
MINIMUM LENGTH	04 -> 64	04
MAXIMUM LENGTH	04 -> 64	64
6 and 14 ONLY	ON or OFF	OFF
CHECK DIGIT	ON or OFF	OFF
CHECK DIGIT XMIT	ON or OFF	OFF

**NOTE:** Interleaved 2 of 5 symbology requires that the code read be an even number of digits.

- **Industrial 2 of 5**

<u>Variables</u>	<u>Selections</u>	<u>Default</u>
ENABLE	ON or OFF	ON
MINIMUM LENGTH	00 -> 64	00
MAXIMUM LENGTH	00 -> 64	64

- **Code 11**

<u>Variables</u>	<u>Selections</u>	<u>Default</u>
ENABLE	ON or OFF	ON
MINIMUM LENGTH	00 -> 64	04
MAXIMUM LENGTH	00 -> 64	64
ONE CHECK DIGIT	ON	
TWO CHECK DIGITS	ON	ON

- **Code 93**

<u>Variables</u>	<u>Selections</u>	<u>Default</u>
ENABLE	ON or OFF	ON
MINIMUM LENGTH	00 -> 64	00
MAXIMUM LENGTH	00 -> 64	64

- **Code 128**

<u>Variables</u>	<u>Selections</u>	<u>Default</u>
ENABLE	ON or OFF	ON
MINIMUM LENGTH	00 -> 64	00
MAXIMUM LENGTH	00 -> 64	64

- **Plessey**

<u>Variables</u>	<u>Selections</u>	<u>Default</u>
ENABLE	ON or OFF	OFF
MINIMUM LENGTH	04 -> 64	04
MAXIMUM LENGTH	04 -> 64	64

- **UPC**

<u>Variables</u>	<u>Selections</u>	<u>Default</u>
UPC A	ON or OFF	ON
UPC E	ON or OFF	ON
2 DIGIT SUPPLEMENT	ON or OFF	ON
5 DIGIT SUPPLEMENT	ON or OFF	ON
CHECK DIGIT XMIT	ON or OFF	ON
NUMBER SYS XMIT	ON or OFF	ON
ZERO SUPPRESS	ON or OFF	ON

- **EAN**

<u>Variables</u>	<u>Selections</u>	<u>Default</u>
EAN.JAN 8	ON or OFF	ON
EAN/JAN 13	ON or OFF	ON
2 DIGIT SUPPLEMENT	ON or OFF	ON
5 DIGIT SUPPLEMENT	ON or OFF	ON
CHECK DIGIT XMIT	ON or OFF	ON

## X. EDIT PROGRAMMING

### CUSTOMER APPLICATIONS PROGRAMMABLE EDIT (CAPE)

It is **strongly advised** that this **section** be read in its entirety and that a **Worksheet** be filled out **BEFORE** you attempt to program any of the **CAPE** features.

The Customer Applications Programmable Edit, referred to as CAPE, is a means by which the user can qualify the raw data record passing through the unit and then define the output format of the data record.

The menu programmable features allow the user the following flexibility.

- **DATA QUALIFICATION:**

1) Specify which port the data record can be received from.

Scanner  
Auxiliary RS 232  
Magnetic Stripe

2) Specify which symbology the data record must be represented by.

Code 3 of 9	Code 11
Codabar	Code 93
I 2 of 5	Plessey
2 of 5	UPC
Code 128	EAN
All = Any symbology, RS 232 or Mag Stripe	

3) Specify the length of the data record.

Actual length  
Variable Length

4) Specify by position in the data record a match to a specific ASCII character.

Example:  
Position 3 of the record must be a "T" and  
position 5 of the record must be a "7".

*Qualification Example:*

A 6 digit Code 3 of 9 bar code with a "5" as the second digit.

Qualify =       Scanner Port  
                  Code 3 of 9  
                  Six digits  
                  "5" = second position

Only a record passing all four qualifications will pass the edit.

- **OUTPUT FORMAT OPTIONS**

- 1) **Add** data and/or Function Codes to the record
  - Preambles
  - Postambles
  - Insert Within Output Record
- 2) **Delete** data from the record.
  - Examples:
    - Do not output field identifiers
    - For Mag Stripe input, only output the Account Number and Expiration Date.
- 3) **Rearrange** data from the input record to match the output format.
- 4) **Repeat** data found in the input record. Output the same data more than once.
- 5) **Define two output formats** for one input record.
  - The second of the two output formats is activated by reading a "Switch Label".

***Output Format Example:***

- 1) Delete and Add

Input = 123T456  
Output = 123<TAB>456<ENTER>

- 2) Add, Delete and Rearrange

Input = ;5928394920033=92059032490834?  
Output= 9999<TAB>5928394920033<ENTER>0592<ENTER>

**EDIT WORKSHEET**

DATA INPUT: \_\_\_\_\_

DATA OUTPUT: \_\_\_\_\_

**EDIT NUMBER:** \_\_\_\_\_ OF \_\_\_\_\_

Secondary Switch: \_\_\_\_\_

Deactivate Switch: \_\_\_\_\_

Secondary Output Record: \_\_\_\_\_

PORT = \_\_\_\_\_ **CODE** \_\_\_\_\_

SYMBOLGY = \_\_\_\_\_ **CODE** \_\_\_\_\_

**INPUT RECORD LENGTH** \_\_\_\_\_

**NUMBER OF INPUT FIELDS** \_\_\_\_\_

#	LENGTH	FUNCTION CODE	MATCH

**NUMBER OF ADDITIONAL FIELDS:** \_\_\_\_\_

#	LENGTH	DATA (Minimum of 15)

**OUTPUT SEQUENCE:** \_\_\_\_\_



**PROGRAMMING EXAMPLE # 1**

Use of **Match** Code & **Added** Function Codes

INPUT RECORD: N1234567

OUTPUT RECORD: 1234<Field Forward>567<Enter>

ENTER EDIT PROGRAMMING

Edit Number **01**  
Port **1** (Scanner)  
Symbology **B** (3 of 9)  
Input Length **08**  
# of Fields **03**  
Field 1  
Length **01** (N)  
Function. Code **4E** (N = Hex 4E)  
Match Code **0N** (Field = N)  
Field 2  
Input Field Length **04** (1234)  
Function Code **0B** (Tab)  
Field 3  
Input Field Length **03** (567)  
Function Code **0D** (Enter)  
Added Fields **00**  
Added Field Length Ignore  
Added Field Data Ignore  
Output Sequence **02, 03**

EXIT EDIT PROGRAMMING

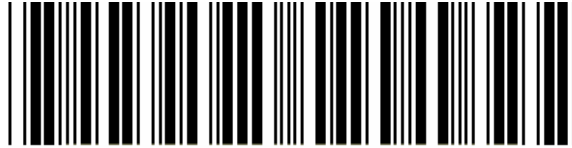

N1234567

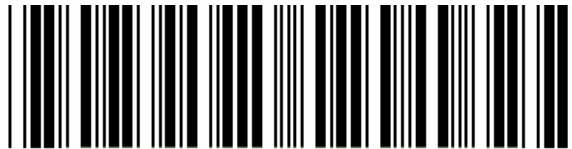

V1234567

- NO CHANGE IN OUTPUT
- MUST BEGIN WITH "N" FOR VALID EDIT

**PROGRAMMING EXAMPLE # 2**

**Added Data & Rearrange Fields**

INPUT RECORD: 1234567890  
OUTPUT RECORD: 67890-BAR<ENTER>12345-CODE<ENTER>

ENTER EDIT PROGRAMMING

Edit Number **01**  
Port: **1** (Scanner)  
Symbology **B** (CODE 3 OF 9)  
Input Record Length **10**  
Fields In Input Record **02**  
Field 1  
Input Field Length **05** (12345)  
Function Code **00** (Null)  
Field 2  
Input Field Length **05** (67890)  
Function Code **00** (Null)  
Added Fields **02**  
Field 3  
Added Field Length **05**  
Added Field Data **2D, 42, 41, 52, 0D**  
( - B A R )  
Field 4:  
Added Field Length **06**  
Added Field Data **2D, 43, 4F, 44, 45, 0D**  
( - C O D E )  
Output Sequence **02, 03, 01, 04**

EXIT EDIT PROGRAMMING



- NO CHANGE IN OUTPUT
- MUST BE 10 DIGITS FOR EDIT

- **METHOD OF PROGRAMMING**

The CAPE features are programmed by first filling out the WorkSheet that is contained in the manual and then programming in the parameters via the Edit Parameter Menu.

The programming sequence involves steps in which you qualify the data as to what it is and how it was generated, then specify how it is to be divided into fields. After the input record definition, additional fields are defined and then the output sequence of all the fields.

- **TERMINOLOGY**

**INPUT RECORD** = Raw data received from a port.  
**FIELD** = A division of the Input Record.  
**ADDITIONAL FIELD** = Data not present in the Input Record, but to be present in the Output Record.  
**OUTPUT RECORD** = Data to be sent to the terminal.  
**FUNCTION CODES** = Keyboard depressions that cause a function to occur rather than data.  
Example: Data equals key entry of a, 1, T, B, 7, +, #, etc., where a function code equals key entry of TAB, CTRL, ENTER, F1, Up Arrow, etc.

- **PORTS**

**SCANNER PORT** = Input from the bar code port on the wedge. Accepts a digital signal from bar code scanning input devices.

**AUXILIARY PORT** = RS 232 input from a device (scale, portable terminal, etc.) attached to the auxiliary port on the wedge. Accepts ASCII data from RS 232 output devices attached to it.

**MAGNETIC PORT** = Input from a Magnetic Stripe Reader attached to the auxiliary port on the wedge.

- **SEQUENCE OF PROGRAMMING**

1) Scan ENTER EDIT PROGRAMMING

2) Specify Edit Number.

- a) A "01" Edit must always be specified.
- b) The "01" edit must always be the first edit.
- c) Maximum number of edits that can be defined are 31, or until all of the memory allocated for edit programming has been used.

3) DATA QUALIFIER: Specify Input Port

The first data qualifier is the port from which the input record will be received. Options include; Scanner, Auxiliary, Magnetic or ALL. If you do not care where the data was entered from, specify ALL.

4) DATA QUALIFIER: Specify Symbology

The Second data qualifier is the symbology that the record must be represented by.

If you know that the data can only be one specific code symbology, specify that symbology. If it does not matter what symbology the data is represented by, then indicate "ALL".

5) DATA QUALIFIER: Specify Input Record Length

The third data qualifier is the length of the input record (number of characters).

If length is not a qualifier, specify "00". The variable field length will be determined by the end of the input record or by the specifying a match code as the following field. The variable field will contain the data up to, but not including the match code field.

6) Specify Fields in the Input Record

The Input Record can be divided into multiple fields. Specify the total number of fields that will be defined.

7) Specify Input Field Length

Starting with the left most (high order) position of the input record, indicate the length of the field.

If the field is to be matched against a specific code, it should be defined as a Match Code. To do so, define a length of "01", specify in the Function Code Parameter the Hex Code to match and then scan "ON" to specify it as a Match Code.

8) Specify Function Code

A single (1) Function Code must be specified to follow a field. A Function Code may be any of the ASCII characters.

Example, a Function Code may be the character "A" or the digit "6" or a keyboard function such as "Field Forward".

If no Function Code is desired, specify "00". All Function Codes are defined using Key Codes. Reference Appendix C, Key Code Chart for a listing.

**NOTE: MATCH CODE**

If the field being defined is to be used as a Match Code Qualifier, the Function Code definition becomes the Key Code for the character to be matched.

9) OPTIONAL ENTRY: Specify Match Code

Any or all characters within an Input Record may be matched individually against a predetermined character.

If matching is NOT desired IGNORE this entry.

If matching is desired

- a) Input Field Length = 01
- b) Function Code = Hex Code to Match to
- c) Match Code = ON

**REPEAT ITEMS 7 - 9 UNTIL ALL FIELDS FOR THE INPUT RECORD HAVE BEEN DEFINED.**

10) Specify Number of Additional Fields

Fields may be added to the Output Record as desired. Indicate how many fields you wish to add. If NO Added Fields are desired scan in 00 and IGNORE 11 & 12.

11) Specify Additional Field Length

Specify the length (number of digits) that will be added in this field definition. Ignore this entry if there are NO Additional Fields.

12) Specify the Field to be Added

Using the ASCII Code Chart, indicate in Hexadecimal each character of the field to be added.

Example:       BAR CODE = 8 digits  
              42 41 52 20   43 4F 44 45  
              B A R Space C O D E

The number of characters entered MUST equal the Added Field Length given in Item 11. The maximum number of characters per field is 15. Ignore this entry if there are NO Additional Fields.

**REPEAT ITEMS 11 AND 12 UNTIL ALL ADDITIONAL FIELDS ARE DEFINED.**

13) Specify Output Record Sequence

Indicate the order in which the fields should be output. If a field is NOT to be included in the output record, do not include it in the sequence. Field Numbering: Input Fields start at 01. Added Fields start with the number immediately following the last Input Field.

Example:       6 Input Fields + 4 Added Fields

For Output Sequencing, the Input Fields are numbered 01 - 06 and the Added Fields are numbered 07 - 10.

14) Scan EXIT EDIT PROGRAMMING

**REPEAT STEPS 1 - 14 FOR ALL INPUT RECORDS REQUIRING AN EDIT.**

**NOTE:** For each Edit, you must first Enter Edit Programming and then Exit Edit Programming after each Edit is defined.

• **PROGRAMMING CONSIDERATIONS - GENERAL**

1. It is strongly advised that prior to attempting any CAPE programming that this Section be read in its entirety and that a worksheet be filled out.
2. Maximum number of Input Records that can be edited = 31, or until all memory allocated for edit programming is used.
3. A beep sequence of 4 Highs and 4 Lows indicates that you have exceeded the memory space available
4. Maximum number of Fields divisions per Input Record = 31.
5. Maximum Input Record Length = 32. The exception to this would be input from a Magnetic Stripe Reader.
6. Default = No Edits.
7. Must always scan in "ENTER" before each Input Record Edit.
8. Must always have a "01" Edit designated. Must always be the first edit entered.
9. Must always answer all options on the parameter menu in sequential order.
10. Must enter a two (2) digit code where defined.  
Example: Input Length of 3 = 0 and 3, not just 3.

- **PROGRAMMING CONSIDERATIONS - "IF" CONDITIONS**

1. Match Code is only programmed when needed.  
If Match Code = ON  
Then "Input Field Length" = 01  
Then "Function Code" = Hex Code to Match to
2. If NO Additional Fields are desired  
Then "Additional Fields" = 00 (must be entered)  
Then "Additional Field Length" & "Additional Field Data" parameters do not have to be entered.
3. If a Input Record is edited  
Then any Preambles and Postambles "WILL NOT" apply to the Input Record.
4. If a Function code is not desired  
Then "Function Code" = 00 (Null)
5. If any & all input is to be accepted  
Example:  
The unit is programmed to read only Code 128 from the Scanner Port, but varying lengths of Code 128 can be entered.  
Then "Input Record Length" = 00 (any length record)  
Then "Fields in Input Record" = 01  
Then "Input Field Length" = 00
6. If a Primary and Secondary output is being defined for an Input Record  
Then the Switch In Label must be the first edit "01".  
The Deactivate Switch Label must be the second edit "02".  
The Deactivate Switch Label is only used when you have entered Secondary output mode and then want to return to Primary output mode without reading a label designated for Secondary output.

- **DEFAULT SETTINGS**

To set default, scan the following sequence:

- 1) Enter Edit Selections
- 2) Default Edit Selections
- 3) Exit Edit Selections

This sets the unit to "NO EDITS". If record edits have been programmed they will be deleted.

- **TURNING ON & OFF EDITS**

Once the unit is programmed for a series of edits, those edits can be turned On and Off by scanning the following sequence. If the edits are turned off, they will remain in memory until they are turned back on or the unit is defaulted.

To Turn OFF - Scan the following

- 1) Enter Edit Selections
- 2) OFF
- 3) Exit Edit Selections

To Turn On - Scan the following

- 1) Enter Edit Selections
- 2) ON
- 3) Exit Edit Selections

- **TURNING ON & OFF INDIVIDUAL EDITS**

Once the unit is programmed for a series of edits, individual edits can be turned On and Off by scanning the following sequence. If an edit is turned off, it will remain in memory until it is turned back on or the unit is defaulted.

Example = Turn Off or On Edit # 03

To Turn OFF Edit 03 - Scan the following

- 1) Enter Edit Selections
- 2) 03
- 3) D

To Turn back ON Edit 03 - Scan the following

- 1) Enter Edit Selections
- 2) 03
- 3) E

- **ADDING AN EDIT**

Additional edits may be added at any time. New edit records must be given an Edit Number not already in use.

Example: If Edit Numbers 01, 05 and 07 have already been defined, you could define a new edit with an Edit Number of 02, or 03, or 08, or 10, etc., as long as the original Edit Numbers are not used.

- **REDEFINING AN EDIT**

Once an edit is already in memory, it can be redefined. It must be remembered that whatever edit number you start redefining on, all subsequent edits, no matter what the order of entry, must be reentered. The Edits are stored by order of entry, not in numerical sequence (Exception, the first edit entered must be 01).

- **ERROR RECOVERY**

If you know you have made an error in the entry of an edit you can:

- 1) Scan "Exit Edit Selections" and then reenter the edit from the beginning.
- 2) If you exit a programming procedure before all options have been answered, that edit number will not be saved.
- 3) Scan "OFF" until you get to a known correct entry. However, if you continue to scan "OFF" until you hear a series of beeps (1 High and 2 Low), you have reached the "Enter Edit Selections" bar code. If you reach this point, you must:
  - Scan "Exit Edit Selections"
  - Scan "Enter Edit Selections"
  - Scan "ON"
  - Scan "Exit Edit Selections"Restart your initial edit programming.

- **MAGNETIC INPUT CONSIDERATIONS**

Since Input Records from magnetic media can vary in length, special consideration must be given to it.

***EXACT RECORD LENGTH***

If the Record Length from the magnetic media is known (Example: Employee Badge), then the edit programming does not change.

**NOTE:** All Sentinels and Field Separators must be taken into account in the editing process.

***VARIABLE RECORD LENGTH***

If the Record Length from the magnetic media is variable (Example: Credit Cards), then the edit programming must allow for it. Program "Input Record Length" = 00 for known variable input. The unit will use the input data from the left most position that has not been edited up until the next Field Separator or Stop Sentinel or Match Code.

**Mag Stripe Input - Recognizing Sentinels & Separators**

When "G" is programmed for the Symbology, the unit will use the Start/Stop Sentinels and the Field Separators to define fields. The unit assumes that the Field Separators and the Stop Sentinel (that are standard in mag stripe data) are the stopping point for a variable length field.

Note that the Sentinels and Separators are still input as data that should be accounted for in the edit programming by indicating an Input Field Length of 01.

**Mag Stripe Input - Recognize End Sentinels Only**

When "E" is programmed for the Symbology, only the End Sentinel will be used to terminate the variable field length.

Note that the Sentinels and Separators are still input as data that should be accounted for in the edit programming by indicating an Input Field Length of 01. A match character may also be defined.



If you are programming more than one magnetic input record, either have one of the records programmed for a variable input length, or use a Match Code Edit to distinguish between the tracks.

If an area of the input data is known to be fixed in length, it can be specified as such.  
 Example: The Expiration Date can be either a four digit field or two fields of two digits in length.

***CARD OUTPUT SEQUENCE***

<u>Track(s)</u>	<u>Output Sequence</u>
1	1
2	2
1 & 2	2, 1

***CREDIT CARD INPUT***

**TRACK 1**

<u>Definition</u>	<u>Data</u>	<u>Input Field Length</u>
Start Sentinel	%	01
Format Code	B	01
Primary Account No	Numeric	00 (Variable)
Field Separator	^	01
Name	Alpha/Numeric	00 (Variable)
Field Separator	^	01
Expiration Date	YYMM	04
Additional Data	Numeric	00 (Variable)
Stop Sentinel	?	01

**TRACK 2:**

<u>Definition</u>	<u>Data</u>	<u>Input Field Length</u>
Start Sentinel	;	01
Primary Account No	Numeric	00 (Variable)
Field Separator	=	01
Expiration Date	YYMM	04
Additional Data	Numeric	00 (Variable)
Stop Sentinel	?	01

### PROGRAMMING EXAMPLE # 3

Magnetic Stripe Input From Credit Card (Track Two)

**INPUT RECORD** = ;1234567890123456=890810100000?

**OUTPUT RECORD** = 1234567890123456<ENTER>0889<ENTER>

ENTER EDIT PROGRAMMING

Edit Number	<b>01</b>
Port	<b>3</b> (Magnetic)
Symbology	<b>G</b> (All)
Input Record Length	<b>00</b> (Variable)
Fields In Input Record	<b>07</b>
Field 1:	
Input Field Length	<b>01</b> (;)
Function Code	<b>00</b> (Null)
Field 2:	
Input Field Length	<b>00</b> (Variable)
Function Code	<b>0D</b> (Enter)
Field 3:	
Input Field Length	<b>01</b> (=)
Function Code	<b>00</b> (Null)
Field 4:	
Input Field Length	<b>02</b> (89)
Function Code	<b>0D</b> (ENTER)
Field 5:	
Input Field Length	<b>02</b> (08)
Function Code	<b>00</b> (Null)
Field 6:	
Input Field Length	<b>00</b> (Variable)
Function Code	<b>00</b> (Null)
Field 7:	
Input Field Length	<b>01</b> (?)
Function Code	<b>00</b> (Null)
Added Fields:	<b>00</b>
Added Field Length	Ignore
Added Field Data	Ignore
Output Sequence	<b>02, 05, 04</b>

EXIT EDIT PROGRAMMING

**PROGRAMMING EXAMPLE # 4**

Primary and Secondary Output Formats: A Primary and Secondary Output Format actually defines two output formats for one input record. The second of the two output formats is activated by reading a "Switch Label".

**SWITCH LABEL:**

When programming for Primary and Secondary Output Records you must define a label that when read will activate the switching. The Switch label MUST be defined as EDIT "01". After indicating Edit #01, Scan "ON" to indicate that the Switch label is being defined. Then, use the Match Code identifiers to indicate the characters in the label that will be used for switching. Once switched, the unit will output the secondary record format on the next input record and then automatically switch back to primary output.

Only one Switch Label may be designated. Do not specify an output sequence for this record edit.

**DEACTIVATE SWITCH LABEL:**

When programming for Primary and Secondary Output Records you must define a label that when read will deactivate the switching. The deactivate or void switch would be used to return to primary output. After indicating Edit #02, Scan "ON" to indicate that the Deactivate Switch label is being defined. Then, use the Match Code identifiers to indicate the characters in the label that will be used for switching. Only one Deactivate Switch Label may be designated. Do not specify an output sequence for this record edit.

**SECONDARY EDIT DEFINITIONS:**

When a Secondary Edit is defined for a record, Scan "ON" immediately following the Edit Number of the Secondary Record. This indicates that when a Switch Label is read that the unit will search for a Secondary Output based on the Input Record qualifiers.

**SEQUENCE OF PROGRAMMING**

- Notes:** "01" edit must always be the first edit.
- "01" Edit must indicate the Switch In Label
- "02" Edit must indicate the Deactivate Switch Label.

INPUT RECORD: 129392844668374500001295

PRIMARY OUTPUT RECORD: 1293<TAB>92844<TAB>6683745<TAB>00001295<ENTER>

SECONDARY OUTPUT RECORD: 1293<TAB>92844<TAB>6683745<TAB>

SWITCH IN LABEL = X

DEACTIVATE SWITCH LABEL = A

ENTER EDIT PROGRAMMING BEFORE EACH EDIT

Edit Number:	<i>01</i>	<i>02</i>	<i>03</i>	<i>04</i>
Switch Label:	<i>ON</i>	<i>ON</i>		<i>ON</i>
Port:	<i>1</i>	<i>1</i>	<i>1</i>	<i>1</i>
Symbology:	<i>B</i>	<i>B</i>	<i>B</i>	<i>B</i>
Input Record Length:	<i>01</i>	<i>01</i>	<i>24</i>	<i>24</i>
Fields In Input Record:	<i>01</i>	<i>01</i>	<i>04</i>	<i>04</i>
F 1:				
Input Field Length:	<i>01</i>	<i>01</i>	<i>04</i>	<i>04</i>
Function Code:	<i>58 (X)</i>	<i>41 (A)</i>	<i>0B</i>	<i>0B</i>
Match Code:	<i>ON</i>	<i>ON</i>		
F 2:				
Input Field Length:			<i>05</i>	<i>05</i>
Function Code:			<i>0B</i>	<i>0B</i>
F 3:				
Input Field Length:			<i>07</i>	<i>07</i>
Function Code:			<i>0B</i>	<i>0B</i>
F 4:				
Input Field Length:			<i>08</i>	<i>08</i>
Function Code:			<i>0D</i>	<i>0D</i>
Added Fields:	<i>00</i>	<i>00</i>	<i>00</i>	<i>00</i>
Field Length:	Ignore	Ignore	Ignore	Ignore
Field Data:	Ignore	Ignore	Ignore	Ignore

Output Sequence:EDIT 01 = IGNORE  
 EDIT 02 = IGNORE  
 EDIT 03 = *01, 02, 03, 04*  
 EDIT 04 = *01, 02, 03*

EXIT EDIT PROGRAMMING AFTER EACH EDIT



Switch  
In Label

**X**

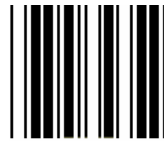

Deactive  
Switch

**A**



1 2 3 4 8 8 0 0 1 9 0 2 4 8 7 5 0 0 0 0 1 2 9 5



9 2 3 3 4 4 5 6 3 5 6 7 3 8 7 7 0 0 0 1 9 9 5 0

## **XI. STATUS CHECK**

This menu page allows the user to display the Status of the parameter selections that have been programmed into the unit.

### **Status Display Notes:**

1. When displaying the Status to the terminal, the operator should start with a clear screen, as the data displayed will take up most of the screen.
2. The scanning of an EXIT symbol is not required, however, an EXIT symbol is on the page in the event you ENTER the Status Check and then decide to Exit without displaying any of the parameters.

The user may choose to transmit the status to either the terminal it is attached to, or transmit the data via the RS 232 Port to an external RS 232 device such as a printer.

### **The user may choose to display:**

- The configuration for General/Auxiliary/Scanner which includes the following menu pages.

Revision Level of Unit		
Terminal ID		
General I	Aux Port	Scanner Port
General II		

- The configuration for Bar Code Selections which include the following menu pages.  
Industrial Codes                      Retail Codes
- The configuration for any programmed CAPE Edits.

## STATUS DISPLAYS WITH DEFAULT SET

### 1. GENERAL I & II, AUXILIARY, SCANNER

#### SCAN:

- ENTER STATUS CHECK
- TO TERMINAL
- A

#### DISPLAY:

REV XX.XX

*(Model & Firmware Revision Level)*

TERMINAL ID..00

#### \*\* GENERAL I \*\*

BEEPER VOLUME.. 7

INPUT INHIBIT CHECK.. DISABLED

KYBD TYPE.. A

INTER CHAR DELAY.. 00

INTER FUNCTION DELAY.. 00

#### \*\* GENERAL II \*\*

MSR TRACK.. 2

BUFFERS.. ENABLED

SOLICIT REC..

SWITCH.. 00000000

#### \*\* SCANNER \*\*

PREAMBLE...

POSTAMBLE..

BEAM REDUNDANCY.. DISABLED

KFC.. DISABLED

CODE ID.. DISABLED

#### \*\* SERIAL I \*\*

PREAMBLE...

POSTAMBLE..

PARITY..EVEN

BAUD RATE..9600

DATA XFER MODE..REC

KFC..DISABLED

## 2. BAR CODE CONFIGURATION

### SCAN:

- ENTER STATUS CHECK
- TO TERMINAL
- B

### DISPLAY:

REV XX.XX (Model & Firmware Revision Level)  
CODABAR  
MIN LGH 00  
MAX LGH 64  
CODE 39 FULL ASCII  
MIN LGH 00  
MAX LGH 64  
I 2-OF-5  
MIN LGH 04  
MAX LGH 64  
ID 2-OF-5  
MIN LGH 04  
MAX LGH 64  
CODE 128  
MIN LGH 00  
MAX LGH 64  
CODE 11 TWO CK DGT                      CODE 93  
MIN LGH 00                                      MIN LGH 00  
MAX LGH 64                                      MAX LGH 64  
UPC-A    UPC-E    2 SUP    5 SUP    CHK OUT NUM SYS  
EAN-8    EAN-13    2 SUP    5 SUP

Note: Under a default setting Plessey is OFF and are not included in the above listing.

### 3. STATUS DISPLAYS WITH 2 SAMPLE EDITS

#### SCAN:

- ENTER EDIT STATUS CHECK
- TO TERMINAL

#### DISPLAY:

The first edit will display.

For subsequent Edits, Repeat the above procedure.

```
EDIT 01
REV XX.XX      (Model & Firmware Revision Level)
EEROM CAP EDIT
EDIT  .. 01
PORT  .. SCANNER
SYMBOLOLOGY .. CODE 39
INPUT LENGTH 08
INPUT FLDS.. 03
          LENGTH FC
          (FLD 01) 01 4E MATCH
          (FLD 02) 04 0B
          (FLD 03) 03 01
ADDED FLDS.. 00
OUTPUT SEQ.. 02 03
-- MORE --
```

```
EDIT 02
QUICKLINK 501.01      (Model & Firmware Revision Level)
EEROM CAP EDIT
EDIT  .. 02
PORT  .. MAGNETICS
SYMBOLOLOGY .. ALL AUX MAGNETICS
INPUT LENGTH 00 VARIABLE
INPUT FLDS.. 07
          LENGTH FC
          (FLD 01) 01 00
          (FLD 02) 00 01
          (FLD 03) 01 00
          (FLD 04) 02 01
          (FLD 05) 02 00
          (FLD 06) 00 00
          (FLD 07) 01 00
ADDED FLDS.. 00
OUTPUT SEQ.. 02 05 04
** END EDITS **
```



## Appendix A: INTERFACES

The following notes apply to the “\*” column of the following Interface Tables:

- 1 = Power Supply Required
- 2 = Intercharacter Delay 01
- 3 = Intercharacter Delay 02
- 4 = All Macintosh = Eprom 21.15C, “Y” Cable
- 5 = Check for Mini Din Connector
- 6 = Input Inhibit
- 7 = Intercharacter Delay 03
- 8 = Input Inhibit with cable 5128
- 9 = Power Supply Required with Laser
- 10 = Power Supply Required with Laser , Input Inhibit with cable 5128
- 11 = 122 Keyboard
- 12 = 030/Parallel Interface
- 13 = Without Keyboard use Cables 0221015 + 0221103
- 14 = Input Inhibit with cable 5127
- 15 = POS 48 Key
- 16 = POS 35 Key
- 17 = IBM 4683- 5B PORT
- 18 = IBM 4683 – PORT 17
- 19 = Requires Chip 63A21
- 20 = All NCD Terminals – Set KYBD to CAPLK ON/OFF – Do not set KYBD to Network
- 21 = NCR 2152 – MSR to OCIA Port – Scanned to Keyboard
- 22 = UNISYS – Reverse Cable
- 23 = Requires EPROM 21.15F
- 24 = Enhanced 102 Keyboard
- 25 = Alternate 105 Keyboard
- 26 = Without Keyboard

## Appendix A: INTERFACES

Terminal	Type	Model # - Part #	ID	Cable #	*	Primary Kybd	Secondary Kybd
ADDS	1010	2300-02CO014	19	0221013	1	/CAPLK	CAPLK
ADDS	3220	2000-02CO002	17	0221024		T/W	
ADDS	4000	2300-02CO014	14	0221018		PC+	ASCII
ADDS	4320	2000-02CO002	13	0221018		/CAPLK	CAPLK
ADDS	VPT 78	2000-02CO002	21	0221007		/CAPLK	CAPLK
ADI	KM-0220	2000-02CO002	62	0221059		122	
ADI	DT 1496/97	2200-02CO007	14	0221015	2	122	
ADI	ST 347/357	2200-02CO007	14	0221015	3	122	
ADI	1577	2200-02CO007	14	0221015	3	T/W	
Alcatel/ITT/Idea	926X	2100-02CO001	06	0221015	1	/CAPLK	CAPLK
ALTOS	5-ASCII	2100-02CO001	28	0221151	1	SHLK	CAPLK
AMPEX	220	2000-02CO002	39	0221037		/CAPLK	CAPLK
AMPEX	230+	2000-02CO002	22	0221037		SHLK	CAPLK
AMPEX/SAI	220E	2000-02CO002	40	0221037		T/W	
API	V 71	2300-02CO014	26	0221015		/CAPLK	CAPLK
APPLE	MAC lici	2100-02CO001	27	0221136	4	/CAPLK	CAPLK
APPLE	ES/30	2100-02CO001	27	0221136	4	/CAPLK	CAPLK
APPLE	MAC PwrBook	2100-02CO001	27	0221136	4	/CAPLK	CAPLK
APPLE	Quadra 700	2100-02CO001	27	0221136	4	T/W	
ATT	6300 PC	2000-02CO002	12	0221022		/CAPLK	CAPLK
ATT	605	All-02CO001	01	0221015		T/W	103
ATT	610	2200-02CO007	21	0221017		T/W	103
ATT	615	2200-02CO007	21	0221017		T/W	
ATT	615EM	2200-02CO007	12	0221017		T/W	
ATT	705	2200-02CO007	28	0221074	5	T/W	
ATT	715	2200-02CO007	12	0221017		T/W	
ATT	715MT	2200-02CO007	28	0221074		T/W	
ATT	4410	2200-02CO007	26	0221017		T/W	
ATT	4425	2200-02CO007	05	0221017		/CAPLK	CAPLK
ATT	6386/WGS	2200-02CO007	01	0221048		/CAPLK	CAPLK
ATT	6312	2200-02CO007	01	0221048		/CAPLK	CAPLK
ATT	6386/PC	All-02CO001	01	0221074		/CAPLK	CAPLK
ATT	6386/SX	All-02CO001	01	0221074		/CAPLK	CAPLK
ATT	6500	2200-02CO007	13	0221017		T/W	
ATT	6528	2200-02CO007	13	0221017		T/W	
ATT	6529	2200-02CO007	13	0221017		T/W	
ATT	UNIX	2200-02CO007	20	0221025	2	T/W	
ATT	6286 EL	ALL-02CO001	01	0221074		/CAPLK	CAPLK
BEEHIVE	9191	2300-02CO014	22	0221031	6	T/W	D/E
C-LINK	196-E	2100-02CO001	21	0221015	7	T/W	
C-ITOH	CIT 224	2000-02CO002	33	0221153		T/W	
CABLEDATA	ESPRIT 3	2000-02CO002	36	0221000		T/W	
COMPAQ	386S-Excell	All-02CO001	01	0221074		/CAPLK	CAPLK
COMTERM	6178	2300-02CO014	22	0221015		T/W	
CUMULUS	HCT	2300-02CO014	50	0221050		/CAPLK	CAPLK

## Appendix A: INTERFACES

Terminal	Type	Model # - Part #	ID	Cable #	*	Primary Kybd	Secondary Kybd
DASI-AT	1183	2300-02CO014	40	0221015		/CAPLK	CAPLK
DASI-AT	1127	2300-02CO014	44	0221072		T/W	
DASI	OSW-2/5	2300-02CO014	30	0221152		/CAPLK	CAPLK
DATA CARE	4002	2300-02CO014	46	0221075		T/W	
DATA GEN	211	2200-02CO007	46	0221119		/CAPLK	CAPLK
DATA GEN	214	2200-02CO007	45	0221045		/CAPLK	CAPLK
DATA GEN	215	2200-02CO007	45	0221045		/CAPLK	CAPLK
DATA GEN	412	2200-02CO007	45	0221045		/CAPLK	CAPLK
DATA GEN	5220 MTX	2200-02CO007	47	0221150		/CAPLK	CAPLK
DEC-DIGITAL	220, 240	2000-02CO002	15	0221023		T/W	
DEC-DIGITAL	320, 330	2000-02CO002	15	0221023		T/W	
DEC-DIGITAL	420	2000-02CO002	15	0221023		T/W	
DEC-DIGITAL	510, 520	All-02CO001	01	0221074		/CAPLK	CAPLK
DEC-DIGITAL	PC 100	2000-02CO002	25	0221023		/CAPLK	CAPLK
Decision Data	386	2100-02CO001	08	0221015		/CAPLK	CAPLK
Decision Data	387 C	2100-02CO001	08	0221015		/CAPLK	CAPLK
Decision Data	3496	2100-02CO001	59	0221134	8	T/W	
Decision Data	3497	2100-02CO001	05	0221009		T/W	
Decision Data	3596-83K	2100-02CO001	62	0221087	9	/SHLK	CAPLK
Decision Data	3596-83K	2100-02CO001	62	0221143	10	/SHLK	CAPLK
Decision Data	3596-102K	2100-02CO001	60	0221067	9	/CAPLK	CAPLK
Decision Data	3596-122K	2100-02CO001	60	0221067	9	/CAPLK	CAPLK
Decision Data	3596-122K	2100-02CO001	60	0221142	10	/CAPLK	CAPLK
Decision Data	3596-NO KB	2100-02CO001	60	0221129	9	/CAPLK	CAPLK
Decision Data	3597-83K	2100-02CO001	62	0221087	9	/SHLK	CAPLK
Decision Data	3597-102K	2100-02CO001	60	0221067	9	/CAPLK	CAPLK
Decision Data	3597-122K	2100-02CO001	60	0221067	9	/CAPLK	CAPLK
Decision Data	3597-NO KB	2100-02CO001	60	0221129	9	/CAPLK	CAPLK
Decision Data	3597-122K	2100-02CO001	60	0221067	9	/CAPLK	CAPLK
Decision Data	3761	2100-02CO001	19	0221016	8	T/W	
Decision Data	3776/77	2100-02CO001	61	0221145	11	/CAPLK	CAPLK
Decision Data	IS 386	2100-02CO001	61	0221145	11	/CAPLK	CAPLK
Decision Data	3791	2100-02CO001	19	0221016	8	T/W	
Decision Data	3781	2100-02CO001	04	0221009		T/W	D/E
DELL	210 PC	All-02CO001	01	0221074		/CAPLK	CAPLK
DTS-POS	500	3100-02CO003	62	0222007		TELE	CALC
EPSON	PC	All-02CO001	01	0221074		/CAPLK	CAPLK
FUJITSU	7770	3100-02CO003	48	0221032	12	N/A	N/A
FUJITSU	7880	3100-02CO003	49	0221032	12	N/A	N/A
FUJITSU	7990	3100-02CO003	50	0221032	12	N/A	N/A
GATEWAY	2000	All-02CO001	01	0221074		/CAPLK	CAPLK
GRID	1450 SX	All-02CO001	01	0221015		/CAPLK	CAPLK

## Appendix A: INTERFACES

Terminal	Type	Model # - Part #	ID	Cable #	*	Primary Kybd	Secondary Kybd
HARRIS	WS471/472	2100-02CO001	03	0221015		/CAPLK	CAPLK
HARRIS	NV481/482	2100-02CO001	03	0221015		/CAPLK	CAPLK
HARRIS	H178-22	2300-02CO014	42	0221041		T/W122	D/E122
HARRIS	H191	2300-02CO014	43	0221041	1	T/W122	
Hewlett Packard	700/41	2200-02CO007	61	0221068		/CAPLK	CAPLK
Hewlett Packard	700/43	2200-02CO007	61	0221068		/CAPLK	CAPLK
Hewlett Packard	700/60	2200-02CO007	43	0221068		/CAPLK	CAPLK
Hewlett Packard	700/92	2200-02CO007	61	0221068		/CAPLK	CAPLK
Hewlett Packard	700/94	2200-02CO007	61	0221068		/CAPLK	CAPLK
Hewlett Packard	700/96	2200-02CO007	61	0221068	1	/CAPLK	CAPLK
Hewlett Packard	VECTRA	All-02CO001	01	0221074		/CAPLK	CAPLK
HDSI	3200	2300-02CO014	53	0221052		/CAPLK	CAPLK
Honeywell	HDS-7	2300-02CO014	23	0221015		T/W	
ICL	DRS 91/06	2000-02CO002	57	0221014		/SHLK	SHLK
IDEA/COURIER	276	2100-02CO001	08	0221147		122	102
IDEA/COURIER	277	2100-02CO001	08	0221147		122	102
I/O	1181 WP	2000-02CO002	14	0221027	6	83	122
I/O	1181 ES	2000-02CO002	14	0221027	6	83	122
I/O	1181 EP	2000-02CO002	14	0221027	6	83	122
I/O	1181 D	2000-02CO002	14	0221027		83	122
I/O	1196 D	2000-02CO002	13	0221027		102	
I/O	1181 D	2000-02CO002	14	0221027		83	122
I/O	1196 D	2000-02CO002	13	0221027		102	
I/O	2496 C/D	2000-02CO002	13	0221027		102	
I/O	2497 C/D	2000-02CO002	14	0221027		83	122
I/O	2497 C/D	2000-02CO002	13	0221027		102	
I/O	2596 G	2000-02CO002	14	0221027		83	122
I/O	2596 G	2000-02CO002	13	0221027		102	
I/O	1197	2000-02CO002	14	0221027		83	122
I/O	1197	2000-02CO002	13	0221027		102	
I/O	1197	2000-02CO002	13	0221027		102	
I/O	2196	2000-02CO002	14	0221027		83	122
I/O	2196	2000-02CO002	13	0221027		102	
I/O	2477	2000-02CO002	14	0221027		83	122
I/O	2477	2000-02CO002	13	0221027		102	
I/O	2677 C/D	2100-02CO001	08	0221074		/CAPLK	CAPLK
I/O	2676 D	2100-02CO001	08	0221074		/CAPLK	CAPLK
INTERCOLOR		2300-02CO014	20	0221002		T/W	
IBM	PC/XT	2100-02CO001	00	0221015		/CAPLK	CAPLK
IBM	PC/XT	2100-02CO001	00	0221015	13	/CAPLK	CAPLK
IBM	PC/AT	2100-02CO001	01	0221015		/CAPLK	CAPLK
IBM	PC/AT	2100-02CO001	00	0221015	13	/CAPLK	CAPLK
IBM	PS/2	2100-02CO001	01	0221074		/CAPLK	CAPLK
IBM	PS/2	2100-02CO001	24	0221074		/CAPLK	CAPLK

**Appendix A: INTERFACES**

Terminal	Type	Model # - Part #	ID	Cable #	*	Primary Kybd	Secondary Kybd
IBM	PS/1	2100-02CO001	01	0221074		/CAPLK	CAPLK
IBM	LAPTOP 70	2100-02CO001	01	0221004		/CAPLK	CAPLK
IBM	3151	2100-02CO001	02	0221058	9	102	
IBM	3153	2100-02CO001	01	0221001	9	/CAPLK	CAPLK
IBM	3161	2100-02CO001	02	0221012		102	
IBM	3163	2100-02CO001	02	0221012		102	
IBM	3179-1	2100-02CO001	03	0221012	6	T/W	D/E
IBM	3179-2	2100-02CO001	04	0221012	8	T/W	
IBM	3180-1	2100-02CO001	05	0221012	8	122	102
IBM	3180-2	2100-02CO001	06	0221012	8	T/W	D/E
IBM	3191	2100-02CO001	07	0221012			
IBM	3192	2100-02CO001	07	0221012			
IBM	3196	2100-02CO001	08	0221012	8	122	102
IBM	3197	2100-02CO001	25	0221012		122	102
IBM	3178	2100-02CO001	18	0221011	6	122	102
IBM	3278	2100-02CO001	29	0221064	6	122	102
IBM	3276	2100-02CO001	29	0221064	6	T/W	D/E
IBM	8775	2100-02CO001	29	0221064	6	T/W	D/E
IBM	3471	2100-02CO001	13	0221058		T/W	D/E
IBM	3472	2100-02CO001	03	0221058		T/W	D/E
IBM	3476/77/78	2100-02CO001	08	0221058		122	102
IBM	3477/87	2100-02CO001	08	0221058	7	122	102
IBM	5291-1	2100-02CO001	32	0221040	6	T/W	
IBM	5291-2	2100-02CO001	32	0221036	14	T/W	
IBM	7546	2100-02CO001	24	0221015		/CAPLK	CAPLK
IBM – POS	3653	3000-02CO003	44	0222013		TELE	CALC
IBM – POS	3653	3100-02CO004	44	0221043		TELE	CALC
IBM – POS	3683	3000-02CO003	43	0221043	15	TELE	CALC
IBM – POS	3683	3100-02CO004	43	0221043	15	TELE	CALC
IBM – POS	3683	3000-02CO003	51	0221043	16	TELE	CALC
IBM – POS	3683	3100-02CO004	51	0221043	16	TELE	CALC
IBM – POS	4683	3000-02CO003	45	0221049	17	N/A	N/A
IBM – POS	4683	3000-02CO003	45	0221100	18	N/A	N/A
IS	391	2300-02CO014	03	0221015	2	122	102
ITT	9210	2200-02CO007	49	0221034	19	110	
ITT	923X	2200-02CO007	30	0221070		T/W	
ITT	9291	2200-02CO007	34	0221034	19	110	
ITT	9292	2200-02CO007	07	0221015		122	102
LEE DATA	1222	2000-02CO002	28	0221154		/CAPLK	CAPLK
LIBERTY	120	2000-02CO002	50	0221135		ASCII	DEC
LIBERTY	120	2000-02CO002	50	0221135		ENC	DEC
LINK	27/28	2000-02CO002	56	0221055		/CAPLK	CAPLK
LINK	MC-5	2100-02CO001	28	0221092	1	SHLK	CAPLK
LINK	MC-70-ASCII	2100-02CO001	50	0221051	1	/CAPLK	CAPLK
LINK	MC-70-105K	2100-02CO001	51	0221092	1	/CAPLK	CAPLK
LINK	MC-70-PCEN	2100-02CO001	53	0221088	1	/CAPLK	CAPLK

**Appendix A: INTERFACES**

Terminal	Type	Model # - Part #	ID	Cable #	*	Primary Kybd	Secondary Kybd
LYNK	096	2100-02CO001	00	0221071		/CAPLK	CAPLK
LYNK	096	2100-02CO001	00	0221015		83	
LYNK	196/E	2100-02CO001	00	0221071	1	/CAPLK	CAPLK
LYNK	196/E	2100-02CO001	00	0221015	1	83	
LYNK	197/C/D	2100-02CO001	00	0221071		/CAPLK	CAPLK
LYNK	197/C/D	2100-02CO001	00	0221015		83	
LYNK LITE	1/2/3	2100-02CO001	00	0221071		/CAPLK	CAPLK
LYNK LITE	1/2/3 MTX	2100-02CO001	17	0221015	1	83	
LYNK LYTE	87A	2100-02CO001	16	0221015	1	122	
MAI BASIC IV	1200	All - 02CO001	01	0221015		/CAPLK	CAPLK
MAI BASIC IV	1400	All - 02CO001	01	0221015		/CAPLK	CAPLK
MAI BASIC IV	1800	All - 02CO001	01	0221015		/CAPLK	CAPLK
MAI BASIC IV	DT-4313	2300-02CO014	16	0221015		T/W	
MEMOREX	2179-1	2100-02CO001	30	0221015		T/W122	D/E122
MEMOREX	2192	2100-02CO001	30	0221015		T/W122	D/E122
MEMOREX	1196	2100-02CO001	08	0221015		T/W	
MEMOREX	1476	2100-02CO001	08	0221015		T/W	
MEMOREX	1487/88/89	2100-02CO001	08	0221015		T/W	
MICROTERM	5530	2000-02CO002	26	0221019	19	T/W	
MOTOROLA	TM3197	2300-02CO014	21	0222005		3200	3100
MOTOROLA	TM3241	2300-02CO014	21	0222005		3200	3100
NCD	14C	All-02CO001	01	0221074	20	/CAPLK	CAPLK
NCD	15B	All-02CO001	01	0221074	20	/CAPLK	CAPLK
NCD	16, 16E	All-02CO001	01	0221074	20	/CAPLK	CAPLK
NCD	17C	All-02CO001	01	0221074	20	/CAPLK	CAPLK
NCD	19,19B,19C	All-02CO001	01	0221074	20	/CAPLK	CAPLK
NCR	2410	All-02CO001	01	0221074		/CAPLK	CAPLK
NCR	2900	2300-02CO014	14	0221018		PC+	ASCII
NCR	2920	2300-02CO014	14	0221018		PC+I	ASCII
NCR	2970	2300-02CO014	13	0221018		ASCII	PC+
NCR	4940	2300-02CO014	18	0222006	1	T/W	
NCR	4970	2000-02CO002	17	0221024		T/W	
NCR	7901	2000-02CO002	19	0221007		/CAPLK	CAPLK
NCR - POS	280	3000-02CO004	52	0221051		TELE	CALC
NCR - POS	280	3100-02CO003	52	0221051		TELE	CALC
NCR - POS	2151	3000-02CO004	36	0221062		TELE	CALC
NCR - POS	2151	3100-02CO003	36	0221038		TELE	CALC
NCR - POS	2152	3000-02CO004	37	0221039		TELE	CALC
NCR - POS	2152	3100-02CO003	37	0221039		TELE	CALC
NCR - POS	2152	3100-02CO003	40	0221089	21	TELE	CALC
NCR - POS	2154	3100-02CO003	39	0222011		TELE	CALC
NCR - POS	2155	3100-02CO003	39	0222011		TELE	CALC

**Appendix A: INTERFACES**

Terminal	Type	Model # - Part #	ID	Cable #	*	Primary Kybd	Secondary Kybd
NCR – POS	7052-32K	3000-02CO004	61	0221061	1	TELE	CALC
NCR – POS	7052-32K	3100-02CO003	61	0221061	1	TELE	CALC
NCR – POS	7052-58K	3000-02CO004	61	0221061	1	TELE	CALC
NCR – POS	7052-58K	3100-02CO003	61	0221061	1	TELE	CALC
NCR – POS	7052-109K	3000-02CO004	60	0221061	1	/CAPLK	CAPLK
NCR – POS	7052-109K	3100-02CO003	60	0221061	1	/CAPLK	CAPLK
ORBIT	155+	2000-02CO002	15	0221023		T/W	
PARADYNE	7812-02	2300-02CO014	27	0221015		T/W	
PHAZE	3270	2200-02CO007	33	0221033	6	T/W	D/E
PHAZE	1191	2200-02CO007	41	0221042	6	T/W	D/E
QUME	QVT 321	2300-02CO014	34	0225087		/CAPLK	CAPLK
STRATUS	V103-ASCII	2100-02CO001	50	0221151	1	/CAPLK	CAPLK
STRATUS	V103-105K	2100-02CO001	51	0221092	1	/CAPLK	CAPLK
STRATUS	V103-PCEN	2100-02CO001	53	0221088	1	/CAPLK	CAPLK
SUN	4/370 GX	2300-02CO014	17	0221010		T/W	
TANDEM	T16 (6530)	2000-02CO002	46	0221046		/CAPLK	CAPLK
TECHNICON	4201	2300-02CO014	47	0221075		T/W	
TECHNICON	4270	2000-02CO002	26	0221090		T/W	
TECHNICON	4270-B	2000-02CO002	26	0221019	19	T/W	
TELETYPE	5420	2200-02CO007	26	0221017		T/W	
TELETYPE	5425	2200-02CO007	25	0221017		/CAPLK	CAPLK
TELEVIDEO	965	2300-02CO014	15	0221072		T/W	
TELEVIDEO	9320	2300-02CO014	15	0221072		T/W	
TELEX	078/079	2100-02CO001	11	0221093	6	T/W	D/E
TELEX	080	2100-02CO001	11	0221093	6	T/W	D/E
TELEX	179/180	2100-02CO001	11	0221093	6	T/W	D/E
TELEX	078/079	2100-02CO001	11	0221015		T/W	D/E
TELEX	080	2100-02CO001	11	0221015		T/W	D/E
TELEX	179/180	2100-02CO001	11	0221015		T/W	D/E
TELEX	191	2100-02CO001	11	0221015	6	T/W	D/E
TELEX	191	2100-02CO001	07	0221015		T/W	D/E
TELEX	78X-80X	2100-02CO001	03	0221015		T/W122	D/E122
TELEX	276	2100-02CO001	29	0221108		T/W	D/E
TELEX	279	2100-02CO001	29	0221108		T/W	D/E
TELEX	1196	2100-02CO001	08	0221015		T/W	D/E
TELEX	2476	2100-02CO001	08	0221015		T/W	D/E
TELEX	197	2100-02CO001	25	0221015		T/W	D/E
TELEX	1197	2100-02CO001	25	0221015		T/W	D/E
TELEX	1192	2100-02CO001	02	0221015		T/W	D/E
TEXAS INST	924	2000-02CO002	63	0221060		/CAPLK	CAPLK
TEXAS INST	928	2200-02CO007	62	0221123	1	T/W	
TEXAS INST	PPC	2000-02CO002	18	0221069		/CAPLK	CAPLK

**Appendix A: INTERFACES**

Terminal	Type	Model # - Part #	ID	Cable #	*	Primary Kybd	Secondary Kybd
UNISYS	SVT 1220	2000-02CO002	16	0221028		T/W	
UNISYS	B-26	2200-02CO007	57	0221057	22	T/W	
UNISYS	SG 2500	2200-02CO007	57	0221057	22	T/W	
UNISYS	T 27	2200-02CO007	58	0221057		/CAPLK	CAPLK
UNISYS	SVT 1120	2200-02CO007	10	0221008		T/W	
UNISYS	UTS 20-40	2200-02CO007	09	0221008	19	T/W	
UNISYS	UVT 1224	2200-02CO007	35	0221035		T/W	D/E
UNISYS	TO 200	2100-02CO001	49	0221157	23	/CAPLK	CAPLK
UNISYS	TO 300	2100-02CO001	56	0221088	24	/CAPLK	CAPLK
UNISYS	TO 300	2100-02CO001	28	0221092	25	/CAPLK	CAPLK
VISENTECH	VS 211	2000-02CO002	20	0221005	1	/SHLK	SHLK
VISENTECH	VS 220	2000-02CO002	49	0221148		/SHLK	SHLK
WYSE	PC	2100-02CO001	52	0221110		/CAPLK	CAPLK
WYSE	30	2100-02CO001	54	0221112		/CAPLK	CAPLK
WYSE	50	2100-02CO001	47	0221047	1	/CAPLK	CAPLK
WYSE	75	2100-02CO001	48	0221047		/CAPLK	CAPLK
WYSE	105/ANSI- Kybd	2100-02CO001	51	0221092	1	/CAPLK	CAPLK
WYSE	PCEN – Kybd	2100-02CO001	53	0221088	1	/CAPLK	CAPLK
WYSE	ASCII-Kybd	2100-02CO001	50	0221151	1	/CAPLK	CAPLK
ZENITH	248 PC	2100-02CO001	01	0221030	25	/CAPLK	CAPLK
ZENTEC	RE-951320	2300-02CO014	12	0221015		T/W	
ZENTEC	4000	2300-02CO014	48	0221075		T/W	



## **Appendix B: BEEP SEQUENCES**

After each successful read the unit will emit an audible tone. The volume of the tone emitted can be programmed within a range of 0 (OFF) to 7 (HIGH).

However, during any of the Programming Modes, the beeper will always return to a HIGH (7) volume to insure that the operator is aware of any problem that may occur.

Below is a list of beeper sequences and their meaning.

<b><u>BEEP SEQUENCE</u></b>	<b><u>MEANING</u></b>
2 HIGH	Power- Up Initialization
1 HIGH	Good Read (Data Entry Mode)
2 LOW, or More	Bad Read (or Buffers Full)
1 HIGH, 1 LOW	Good Read in Programming
1 HIGH, 2 LOW	Record Out Of Sequence in Program Mode
4 HIGH, 4 LOW	Memory allocated for Edits has been exceeded

## Appendix C: KEY CODE CHARTS

When programming the unit to emulate data entry into an existing application, it is often necessary to insert additional digits, characters or function keys (Enter, Tab, ALT C, etc.)

The following key codes are used when programming preambles, postambles, edits or scale solicits. The program can call for the transmission of specific keys either one at a time, or in sequence. They are also used in an Edit sequence to define the character or character to match against.

### Key Code Table Information:

- **Definition**  
Gives the definition for the key either as a character or as a keyboard function.
  
- **Program Code**  
A two digit code used to define the character in the programming sequence.  
Example:           41 = A  
                      09 = Tab or Field Forward  
                      2B = + (Plus)  
                      C8 = PF9, CMD 9 or F9
  
- **Code 3 of 9**  
The character or sequence of characters that are needed if the key depression is to be embedded in a Code 3 of 9 Bar Code.  
Example:           Bar Code Input -           12345\$I  
                      Output to Terminal -       12345<Tab>  
                      Bar Code Input -           00/J9384+C\$M  
                      Output to Terminal -       00\*9384c<CR>

### NOTES:

- 1) The Keyboard Function Code menu selection for the scanner port must be turned on.
- 2) If the Keyboard Function Code selection is OFF, and Code 3 of 9 Full ASCII is ON -
  - the 2 digit character sequences representing function codes will be ignored.
  - the 2 digit character sequences representing characters will be transmitted correctlyExample:           Bar Code Input -           12345\$I67/J890  
                      Output to Terminal -       1234567\*890  
  The \$I representing the Tab key was ignored.
- 3) If the Keyboard Function Code selection is OFF, and Code 3 of 9 Full ASCII is OFF -  
All characters will be transmitted individually.  
Example:           Bar Code Input -           12345\$I67/J890  
                      Output to Terminal -       12345\$I67/J890

### IMPORTANT:

Do not embed within a data record those keyboard functions that will cause a system inhibit condition before the remainder of the record is sent to the terminal. Loss of data will result.

ASCII Definition	Prog. Code	Code 3 of 9	ASCII Definition	Prog. Code	Code 3 of 9
Null	00	%U	Sp space	20	SP
SOH	01	\$A	! exclam	21	/A
STX	02	\$B	" quote	22	/B
ETX	03	\$C	# number	23	/C
EOT	04	\$D	\$ dollar	24	/D
ENQ	05	\$E	% percent	25	/E
ACK	06	\$F	& amprsnd	26	/F
BEL	07	\$G	^ acute	27	/G
BS	08	\$H	( op paren	28	/H
HT	09	\$I	) cl paren	29	/I
LF	0A	\$J	* asterisk	2A	/J
VT	0B	\$K	+ plus	2B	/K
FF	0C	\$L	, comma	2C	/L
CR	0D	\$M	- minus	2D	-
SO	0E	\$N	. period	2E	.
SI	0F	\$O	/ slash	2F	/O
DLE	10	\$P	0 0	30	0
DC1	11	\$Q	1 1	31	1
DC2	12	\$R	2 2	32	2
DC3	13	\$S	3 3	33	3
DC4	14	\$T	4 4	34	4
NAK	15	\$U	5 5	35	5
SYN	16	\$V	6 6	36	6
ETB	17	\$W	7 7	37	7
CAN	18	\$Y	8 8	38	8
EM	19	\$Z	9 9	39	9
SUB	1A	\$Z	: colon	3A	/Z
ESC	1B	%A	; semicln	3B	%F
FS	1C	%B	< ls than	3C	%G
GS	1D	%C	= equal	3D	%H
RS	1E	%D	> gt than	3E	%I
US	1F	%E	? questn	3F	%J

ASCII Definition		Prog. Code	Code 3 of 9	ASCII Definition		Prog. Code	Code 3 of 9
@	at sign	40	%V	‘	grave	60	%W
A	Up case	41	A	a	Lw case	61	+A
B	Up case	42	B	b	Lw case	62	+B
C	Up case	43	C	c	Lw case	63	+C
D	Up case	44	D	d	Lw case	64	+D
E	Up case	45	E	e	Lw case	65	+E
F	Up case	46	F	f	Lw case	66	+F
G	Up case	47	G	g	Lw case	67	+G
H	Up case	48	H	h	Lw case	68	+H
I	Up case	49	I	i	Lw case	69	+I
J	Up case	4A	J	j	Lw case	6A	+J
K	Up case	4B	K	k	Lw case	6B	+K
L	Up case	4C	L	l	Lw case	6C	+L
M	Up case	4D	M	m	Lw case	6D	+M
N	Up case	4E	N	n	Lw case	6E	+N
O	Up case	4F	O	o	Lw case	6F	+O
P	Up case	50	P	p	Lw case	70	+P
Q	Up case	51	Q	q	Lw case	71	+Q
R	Up case	52	R	r	Lw case	72	+R
S	Up case	53	S	s	Lw case	73	+S
T	Up case	54	T	t	Lw case	74	+T
U	Up case	55	U	u	Lw case	75	+U
V	Up case	56	V	v	Lw case	76	+V
W	Up case	57	W	w	Lw case	77	+W
X	Up case	58	X	x	Lw case	78	+X
Y	Up case	59	Y	y	Lw case	79	+Y
Z	Up case	5A	Z	z	Lw case	7A	+Z
[	Op brkt	5B	%K	{	op brace	7B	%P
\	lft slash	5C	%L		vert rule	7C	%Q
]	cl brkt	5D	%M	}	cl brace	7D	%R
^	Circumf x	5E	%N	~	overscore	7E	%S
_	Und line	5F	%O		del	7F	

## Appendix D: KEYBOARD FUNCTION RECORDS

Keyboard Function Records are used to manipulate the cursor on the display and to cause the terminal to enter modes of operation that ordinarily require a keystroke.

Keyboard Function Record are defined as three-byte (ASCII characters) records that when scanned will emulate the keyboard function to the terminal. To use the Keyboard Functions Records, extended code 3 of 9 must be enabled.

### Bar Code



# 0 1



# 0 2



# 0 3



# 0 4



# 0 5



# 0 6



# 0 7



# 0 8

### Bar Code



# 0 9



# 1 0



# 1 1



# 1 2



# 1 3



# 1 4



# 1 5



# 1 6

Bar Code



# 1 7



# 1 8



# 1 9



# 2 0



# 2 1



# 2 2



# 2 3



# 2 4

Bar Code



# 2 5



# 2 6



# 2 7



# 2 8



# 2 9



# 3 0



# 3 1

## Keyboard Functions Supported

**A = Hex Code**

**B = Keyboard Function Code**

**C = Keyboard Function Record**

Column 1		Column 2	
<b>ADDS</b> – 4000, 4320 <b>API</b> – V 71 <b>ATT</b> – 605, 705, 6286, 6386 <b>DASI</b> - 02W-2/5 <b>DELL</b> – PC <b>Epson</b> – PC <b>IBM</b> – PC's & PS/2's <b>IS</b> – 391	<b>Lynk</b> – 096,196,187,Lite <b>MAI Basic IV</b> – 1200, 1400,1800 <b>NCD-</b> All Models <b>Paradyne</b> – 7812 PC <b>SUN</b> – 4/370 gx <b>Zenith</b> – 248 PC <b>Zentech</b> – RE 9513	<b>ADI</b> – All Models <b>IDEA</b> – 276, 277 <b>Decision Datal</b> – All <b>IBM</b> – 3180-1, 3191, 3192, 3196, 3197, 3476, 3477  <b>* 122 Keyboards</b>	<b>ITT</b> - 9292 <b>I/O</b> – All Models <b>Telex/Memorex-</b> 191, 196, 197, 1192, 1196, 1197, 2192  <b>* 122 Keyboards</b>

A	B	C	1 Keyboard Function	2 Keyboard Function
00	\$U	#00		
01	\$A	#01	Enter	
02	\$B	#02		
03	\$C	#03		
04	\$D	#04		
05	\$E	#05	Solicit Aux Port	Solicit Aux Port
06	\$F	#06		
07	\$G	#07		New Line
08	\$H	#08		
09	\$I	#09		
0A	\$J	#10		
0B	\$K	#11	Field Forward	Field Forward
0C	\$L	#12	Delete	Delete
0D	\$M	#13	New Line	New Line
0E	\$N	#14	Insert	Insert
0F	\$O	#15		
10	\$P	#16		Error Reset
11	\$Q	#17	Home	Home
12	\$R	#18	Print	
13	\$S	#19	BackSpace	BackSpace
14	\$T	#20	BackField	BackField
15	4U	#21		
16	\$V	#22	F1	F1
17	\$W	#23	F2	F2
18	\$X	#24	F3	F3
19	\$Y	#25	F4	F4
1A	\$Z	#26	F5	F5
1B	%A	#27	F6	F6
1C	%B	#28	F7	F7
1D	%C	#29	F8	F8
1E	%D	#30	F9	F9
1F	%E	#31	F10	F10

## Keyboard Functions Supported

**A = Hex Code**

**B = Keyboard Function Code**

**C = Keyboard Function Record**

Column 3		Column 4
<b>ATT</b> – 6500, 6528, 6529 <b>Decision Data</b> – All <b>Harris</b> – 191 <b>IBM</b> – 3151,3161, 3163,3179-1, 3191, 3192, 3196, 3197, 3180-1, 3471, 3472, 3476, 3477 <b>* 102 Keyboard</b>	<b>ICL</b> – DRS 92/06 <b>IDEA</b> – 276, 277 <b>I/O</b> - All <b>ITT</b> – 9292, 9210, 923X <b>Lynk</b> – Lite <b>Memorex</b> – 2192 <b>* 102 Keyboard</b>	<b>IBM</b> – 3180-2, 3179-2, 5291-1, 5291-2 <b>Decision Data</b> – All Models <b>I/O</b> – All Models  <b>* 83 Keyboard</b>

A	B	C	3 Keyboard Function	4 Keyboard Function
00	\$U	#00		
01	\$A	#01	Enter	Enter
02	\$B	#02		
03	\$C	#03		
04	\$D	#04		
05	\$E	#05	Solicit Aux Port	Solicit Aux Port
06	\$F	#06		
07	\$G	#07		New Line
08	\$H	#08		Field Exit
09	\$I	#09		Field +
0A	\$J	#10		Field -
0B	\$K	#11	Field Fwd	Field Fwd
0C	\$L	#12	DEL	DEL
0D	\$M	#13	New Line	New Line
0E	\$N	#14	Insert	Insert
0F	\$O	#15	Clear	Clear
10	\$P	#16	Error Reset	Error Reset
11	\$Q	#17	Home	Home
12	\$R	#18	Print Screen	Print Screen
13	\$S	#19	Back Space	Back Space
14	\$T	#20	Back Field	Back Field
15	4U	#21		
16	\$V	#22	CMD1	CMD1
17	\$W	#23	CMD2	CMD2
18	\$X	#24	CMD3	CMD3
19	\$Y	#25	CMD4	CMD4
1A	\$Z	#26	CMD5	CMD5
1B	%A	#27	CMD6	CMD6
1C	%B	#28	CMD7	CMD7
1D	%C	#29	CMD8	CMD8
1E	%D	#30	CMD9	CMD9
1F	%E	#31	CMD10	CMD10



## Keyboard Functions Supported

**A = Hex Code**

**B = Keyboard Function Code**

**C = Keyboard Function Record**

Column 5		Column 6		
<b>Beehive</b> – 9191 <b>CLI</b> - C-Link 196 E <b>Comterm</b> – 6178 <b>Harris</b> – H 178 <b>IBM</b> – 3178, 3278, 3276, 8775	<b>ITT</b> – 9291 <b>Phaze</b> – 3270, 1191 <b>Telex</b> – 078, 079, 080, 179, 180, 191, 276, 279	<b>ADDS</b> – 3220 <b>ADI</b> – KM-0220 <b>Altos</b> – 5 <b>AMPEX</b> – 220,230+ <b>DEC</b> – 220, PC 100 <b>HDSI</b> – 3200	<b>LINK</b> – MC-5 <b>Microterm</b> – 5530 <b>NCR</b> – 4970 <b>Orbit</b> – 155+ <b>Qume</b> – 321 <b>Technicon</b> - 4270	<b>Unisys</b> – SVT 1220, UVT 1224, TO 300 <b>WYSE</b> – 30, 50, 75, 85 All ASCII & 105 Kybds

A	B	C	5 Keyboard Function	6 Keyboard Function
00	\$U	#00		
01	\$A	#01	Enter	Enter
02	\$B	#02		PF1
03	\$C	#03		PF2
04	\$D	#04		PF3
05	\$E	#05	Solicit Aux Port	Solicit Aux Port
06	\$F	#06		Break – Wyse 85
07	\$G	#07	New Line	New Line
08	\$H	#08	Field Exit	PF4
09	\$I	#09	Field +	Tab Forward
0A	\$J	#10	Field -	
0B	\$K	#11	Field Fwd	
0C	\$L	#12	DEL	Remove
0D	\$M	#13	New Line	New Line
0E	\$N	#14	Insert	Insert Here
0F	\$O	#15	Erase	Up Arrow
10	\$P	#16	Error Reset	Left Arrow
11	\$Q	#17		Down Arrow
12	\$R	#18	Print Screen	Right Arrow
13	\$S	#19	Back Space	Back Space
14	\$T	#20	Back Field	Back Field
15	4U	#21		
16	\$V	#22	CMD1	F1
17	\$W	#23	CMD2	F2
18	\$X	#24	CMD3	F3
19	\$Y	#25	CMD4	F4
1A	\$Z	#26	CMD5	F5
1B	%A	#27	CMD6	F6
1C	%B	#28	CMD7	F7
1D	%C	#29	CMD8	F8
1E	%D	#30	CMD9	F9
1F	%E	#31	CMD10	F10

## Keyboard Functions Supported

**A = Hex Code**

**B = Keyboard Function Code**

**C = Keyboard Function Record**

Column 7	Column 8	Column 9	Column 10	Column 11
WYSE – All PC Enhanced Kybds	Data General – D214, D211, MTX 5220 Link – MC 27, 28 NCR - 4840 Tandem – T16 Unisys – T27 Visentech – VS 211	Unisys – B26	Apple – Macintosh lici	Adds – 1010 ATT – 4410, 4425, 715, 615EM Cumulus – HCT Teletype – 5425

A	B	C	7 Keyboard Function	8 Keyboard Function	9 Keyboard Function	10 Keyboard Function	11 Keyboard Function
00	\$U	#00					
01	\$A	#01	Enter	Enter	Enter	Enter	Enter
02	\$B	#02	Caps Lock		Next Page		
03	\$C	#03			Prev Page		
04	\$D	#04			Mark	Tab Forward	
05	\$E	#05	Solicit Aux Port	Solicit Aux Port	Solicit Aux Port	Solicit Aux Port	Solicit Aux Port
06	\$F	#06			Bound		
07	\$G	#07	Up Arrow	New Line	New Line	Up Arrow	Return
08	\$H	#08	Left Arrow		Next	Left Arrow	Back Space
09	\$I	#09	Down Arrow	Tab Fwd	Tab Fwd	Down Arrow	Tab Fwd
0A	\$J	#10	Right Arrow	New Line	Cancel	Right Arrow	Line Feed
0B	\$K	#11	Tab Forward		Move	Page Up	NUM Lock
0C	\$L	#12	DEL	DEL	DEL	Page Down	DEL
0D	\$M	#13	Enter – RT Kybd	New Line	New Line	Return	Return
0E	\$N	#14	Insert	Erase EOL	Over Type	DEL	
0F	\$O	#15	F11	Erase Page	Copy	Home	Erase Screen
10	\$P	#16	F12	Print Screen	Finish	End	
11	\$Q	#17	Home	Home	Action	F 11	Home
12	\$R	#18	Print Screen	Up Arrow	Up Arrow	F 12	Up Arrow
13	\$S	#19	Back Space	Left Arrow	Left Arrow	F 13	Left Arrow
14	\$T	#20	Back Tab	Down Arrow	Down Arrow	F 14	Down Arrow
15	4U	#21		Right Arrow	Right Arrow	F 15	Right Arrow
16	\$V	#22	F1	F1	F1	F1	F1
17	\$W	#23	F2	F2	F2	F2	F2
18	\$X	#24	F3	F3	F3	F3	F3
19	\$Y	#25	F4	F4	F4	F4	F4
1A	\$Z	#26	F5	F5	F5	F5	F5
1B	%A	#27	F6	F6	F6	F6	F6
1C	%B	#28	F7	F7	F7	F7	F7
1D	%C	#29	F8	F8	F8	F8	F8
1E	%D	#30	F9	F9	F9	F9	F9
1F	%E	#31	F10	F10	F10	F10	F10

## Keyboard Functions Supported

**A = Hex Code**

**B = Keyboard Function Code**

**C = Keyboard Function Record**

Column 12	Column 13	Column 14	Column 15	Column 16
ATT – Unix PC, 610, 615	Honeywell – HDS-7 HP– 700/92, 700/96, 700/60	NCR - 7901 Motorola – TM 3241, TM 3197	AMPEX/SAI – 220E DASI – AT1183, AT1127	Datacare - 4002 Zentec – 4000

A	B	C	12 Keyboard Function	13 Keyboard Function	14 Keyboard Function	15 Keyboard Function	16 Keyboard Function
00	\$U	#00					
01	\$A	#01	Enter	Enter	Enter	Enter	Enter
02	\$B	#02			Alpha Lock	PF1	
03	\$C	#03				PF2	
04	\$D	#04				PF3	
05	\$E	#05	Solicit Aux Port	Solicit Aux Port	Solicit Aux Port	Solicit Aux Port	Solicit Aux Port
06	\$F	#06					
07	\$G	#07	New Line	Carriage Return	New Line	New Line	New Line
08	\$H	#08		Back Space	Back Space	PF4	
09	\$I	#09		Tab Fwd	Tab Fwd	Tab Fwd	Tab Fwd
0A	\$J	#10			Line Feed		New Line
0B	\$K	#11					
0C	\$L	#12	DEL	DEL	Rub Out	Remove	Insert
0D	\$M	#13	New Line	Carriage Return	New Line	New Line	New Line
0E	\$N	#14		Insert	ESC	Insert Here	Erase EOF
0F	\$O	#15		Erase Screen	Erase Screen	Up Arrow	Erase Page
10	\$P	#16		Error Reset		Left Arrow	Send
11	\$Q	#17	Home	Home	Home	Down Arrow	Home
12	\$R	#18		Delete Line	Up Arrow	Right Arrow	Up Arrow
13	\$S	#19	Back Space	Erase & Page	Left Arrow	Back Space	Left Arrow
14	\$T	#20	Back Tab	Erase & File	Down Arrow	Print Screen	Down Arrow
15	4U	#21		Insert Line	Right Arrow		Right Arrow
16	\$V	#22	CMD1	F1	F1	F1	F1
17	\$W	#23	CMD2	F2	F2	F2	F2
18	\$X	#24	CMD3	F3	F3	F3	F3
19	\$Y	#25	CMD4	F4	F4	F4	F4
1A	\$Z	#26	CMD5	F5	F5	F5	F5
1B	%A	#27	CMD6	F6	F6	F6	F6
1C	%B	#28	CMD7	F7	F7	F7	F7
1D	%C	#29	CMD8	F8	F8	F8	F8
1E	%D	#30	CMD9	F9	F9	F9	F9
1F	%E	#31	CMD10	F10	F10	F10	F10

## Keyboard Functions Supported

A = Hex Code

B = Keyboard Function Code

C = Keyboard Function Record

Column 17	Column 18	Column 19	Column 20	Column 21
Texas Inst – 924 ADDS – VPT-78	Texas Inst – PPC, 928	Cabledata – Esprit III	Intercolor	Unisys – UTS 20, 30, 40, SVT 1120

A	B	C	17 Keyboard Function	18 Keyboard Function	19 Keyboard Function	20 Keyboard Function	21 Keyboard Function
00	\$U	#00					
01	\$A	#01	Enter	Enter	Enter	Enter	Enter
02	\$B	#02	PF 11		Caps Lock On	PF1	
03	\$C	#03	PF 12		Up Arrow	PF2	
04	\$D	#04	Enter		Left Arrow	PF3	
05	\$E	#05	Solicit Aux Port	Solicit Aux Port	Solicit Aux Port	Solicit Aux Port	Solicit Aux Port
06	\$F	#06	ATTN	Up Arrow	Down Arrow		
07	\$G	#07	Up Arrow	Left Arrow	Enter	New Line	Carriage Return
08	\$H	#08	Left Arrow	Down Arrow	Right Arrow	PF4	Back Space
09	\$I	#09	Down Arrow	Right Arrow	Caps Lock Off	Tab Fwd	Tab Fwd
0A	\$J	#10	Right Arrow	Line Feed	Line Feed		Line Feed
0B	\$K	#11	Tab Fwd	Tab Fwd	Tab Fwd	Delete	Erase Char
0C	\$L	#12	DEL	DEL	Delete Char	Delete Line	Form Feed
0D	\$M	#13	Return	Return	Return	New Line	Carriage Return
0E	\$N	#14	Insert	Insert	Insert Char	Insert Line	Insert in Line
0F	\$O	#15	Erase Field	F11	Clear Field	Up Arrow	Insert in Display
10	\$P	#16	CMD	F12	Clear All	Left Arrow	Delete Line
11	\$Q	#17	Home	Home	Home	Down Arrow	SOE
12	\$R	#18	Print	Print	ESC	Right Arrow	Tab Set
13	\$S	#19	Back Space	Back Space	Back Space	Back Space	Delete in Line
14	\$T	#20	Back Tab	Back Tab	Back Up	Print Screen	Erase in Display
15	4U	#21	ESC		Page		
16	\$V	#22	F1	F1	F1	F1	Keyboard UNLK
17	\$W	#23	F2	F2	F2	F2	Erase to EOD
18	\$X	#24	F3	F3	F3	F3	Erase to EOL
19	\$Y	#25	F4	F4	F4	F4	Erase to EOR
1A	\$Z	#26	F5	F5	F5	F5	Tab Back
1B	%A	#27	F6	F6	F6	F6	
1C	%B	#28	F7	F7	F7	F7	Delete in Line
1D	%C	#29	F8	F8	F8	F8	Insert Here
1E	%D	#30	F9	F9	F9	F9	Home
1F	%E	#31	F10	F10	F10	F10	Message Wait

## Keyboard Functions Supported

A = Hex Code

B = Keyboard Function Code

C = Keyboard Function Record

Column 22	Column 23	Column 24	Column 25	Column 26
Wang – 2210	Technicon – 4201	MAI Basic IV – DT 4313	Visentech – VS 220	Liberty – 120

A	B	C	22 Keyboard Function	23 Keyboard Function	24 Keyboard Function	25 Keyboard Function	26 Keyboard Function
00	\$U	#00					
01	\$A	#01	PAD Return	Return	Enter	Enter	Enter
02	\$B	#02	PF 11	SP1	Caps Lock	PF1	
03	\$C	#03	PF 12	SP2	I	PF2	
04	\$D	#04	GL	SP3	II	PF3	
05	\$E	#05	Solicit Aux Port	Solicit Aux Port	Solicit Aux Port	Solicit Aux Port	Solicit Aux Port
06	\$F	#06	Back Space		III	PF4	Tab Forward
07	\$G	#07	Return	Return	IV	Up Arrow	Tab Back
08	\$H	#08	Back Tab	Back Space	F 11	Left Arrow	Back Space
09	\$I	#09	Tab Fwd	Back Tab	F 12	Down Arrow	Insert Char
0A	\$J	#10	Return	Tab Fwd	F 13	Right Arrow	Delete Char
0B	\$K	#11	Insert	Reset	F 14	F6	Insert Line
0C	\$L	#12	DEL		Delete	F7	Delete Line
0D	\$M	#13	Return	New Line	Return	Return	Return
0E	\$N	#14	Insert	Up Arrow	Tab	F8	PF1
0F	\$O	#15	Erase Field	Left Arrow	Back Space	F9	PF2
10	\$P	#16	Next	Down Arrow	ESC	F11	PF3
11	\$Q	#17	Home	Right Arrow		F12	PF4
12	\$R	#18	Up Arrow	Send	Up Arrow	F13	Up Arrow
13	\$S	#19	Left Arrow	REV	Left Arrow	F14	Left Arrow
14	\$T	#20	Down Arrow	Enter	Down Arrow		Down Arrow
15	4U	#21	Right Arrow	SP1	Right Arrow	Back Space	Right Arrow
16	\$V	#22	PF1	SP2	F1	Print Screen	PF1
17	\$W	#23	PF2	SP3	F2		PF2
18	\$X	#24	PF3	SP4	F3		PF3
19	\$Y	#25	PF4	SP5	F4		PF4
1A	\$Z	#26	PF5	SP6	F5		PF5
1B	%A	#27	PF6		F6		PF6
1C	%B	#28	PF7		F7		PF7
1D	%C	#29	PF8		F8		PF8
1E	%D	#30	PF9		F9		PF9
1F	%E	#31	PF10		F10		PF10

## Keyboard Functions Supported

**A = Hex Code**

**B = Keyboard Function Code**

**C = Keyboard Function Record**

<b>Column 27</b>	
<b>C-ITOH – CIT 224</b>	

<b>A</b>	<b>B</b>	<b>C</b>	<b>27 Keyboard Function</b>
<b>00</b>	\$U	#00	
<b>01</b>	\$A	#01	Enter
<b>02</b>	\$B	#02	PF1
<b>03</b>	\$C	#03	PF2
<b>04</b>	\$D	#04	PF3
<b>05</b>	\$E	#05	Solicit Aux Port
<b>06</b>	\$F	#06	
<b>07</b>	\$G	#07	New Line
<b>08</b>	\$H	#08	PF4
<b>09</b>	\$I	#09	Tab Fwd
<b>0A</b>	\$J	#10	F 11
<b>0B</b>	\$K	#11	F 12
<b>0C</b>	\$L	#12	Remove
<b>0D</b>	\$M	#13	New Line
<b>0E</b>	\$N	#14	Insert Here
<b>0F</b>	\$O	#15	Up Arrow
<b>10</b>	\$P	#16	Left Arrow
<b>11</b>	\$Q	#17	Down Arrow
<b>12</b>	\$R	#18	Right Arrow
<b>13</b>	\$S	#19	Back Space
<b>14</b>	\$T	#20	F 13
<b>15</b>	4U	#21	F 14
<b>16</b>	\$V	#22	F1
<b>17</b>	\$W	#23	F2
<b>18</b>	\$X	#24	F3
<b>19</b>	\$Y	#25	F4
<b>1A</b>	\$Z	#26	F5
<b>1B</b>	%A	#27	F6
<b>1C</b>	%B	#28	F7
<b>1D</b>	%C	#29	F8
<b>1E</b>	%D	#30	F9
<b>1F</b>	%E	#31	F10

## Keyboard Functions Supported

A = Hex Code

B = Keyboard Function Code

C = Keyboard Function Record

A	B	C
00	\$U	#00
01	\$A	#01
02	\$B	#02
03	\$C	#03
04	\$D	#04
05	\$E	#05
06	\$F	#06
07	\$G	#07
08	\$H	#08
09	\$I	#09
0A	\$J	#10
0B	\$K	#11
0C	\$L	#12
0D	\$M	#13
0E	\$N	#14
0F	\$O	#15
10	\$P	#16
11	\$Q	#17
12	\$R	#18
13	\$S	#19
14	\$T	#20
15	4U	#21
16	\$V	#22
17	\$W	#23
18	\$X	#24
19	\$Y	#25
1A	\$Z	#26
1B	%A	#27
1C	%B	#28
1D	%C	#29
1E	%D	#30
1F	%E	#31

IBM 3653 – 30 Key

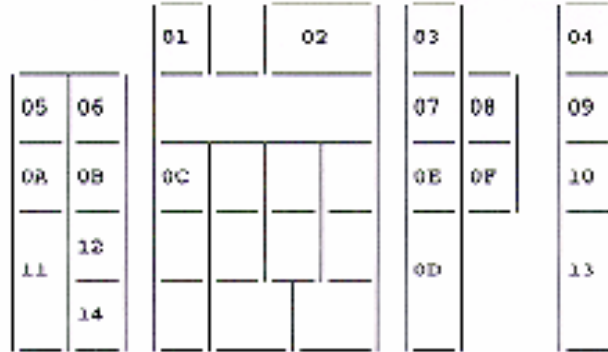

IBM 3653 – 48 Key

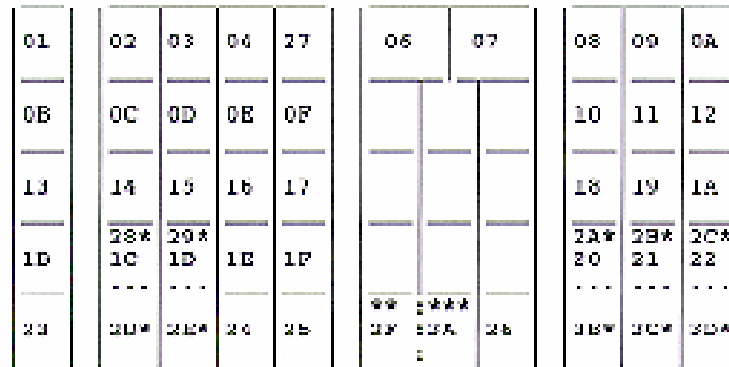

- \* Denotes ASCII Function Code to be used when Single Position Key Cap is Used.
- \*\* If this single key is used as the single digit zero, switch parameter 2 must be on
- \*\*\* If this single key is used as the single digit zero, switch parameter 2 must be on

## Keyboard Functions Supported

A = Hex Code

B = Keyboard Function Code

C = Keyboard Function Record

A	B	C
00	\$U	#00
01	\$A	#01
02	\$B	#02
03	\$C	#03
04	\$D	#04
05	\$E	#05
06	\$F	#06
07	\$G	#07
08	\$H	#08
09	\$I	#09
0A	\$J	#10
0B	\$K	#11
0C	\$L	#12
0D	\$M	#13
0E	\$N	#14
0F	\$O	#15
10	\$P	#16
11	\$Q	#17
12	\$R	#18
13	\$S	#19
14	\$T	#20
15	4U	#21
16	\$V	#22
17	\$W	#23
18	\$X	#24
19	\$Y	#25
1A	\$Z	#26
1B	%A	#27
1C	%B	#28
1D	%C	#29
1E	%D	#30
1F	%E	#31

### IBM 3653 – 35 Key

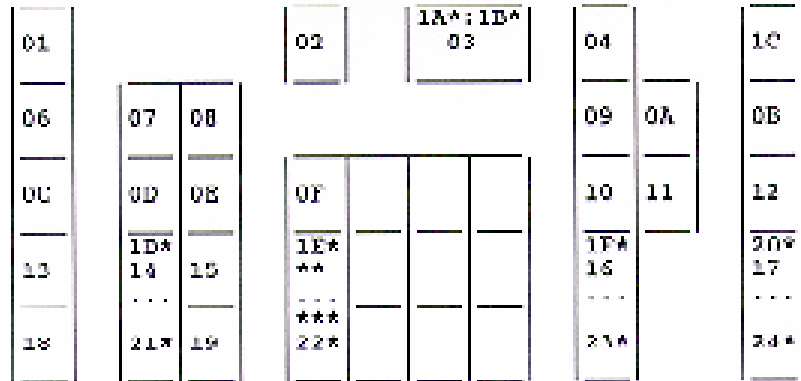

- \* Denotes ASCII Function Code to be used when Single Position Key Cap is Used.
- \*\* If this single key is used as the single digit zero, switch parameter 2 must be on
- \*\*\* If this single key is used as the single digit zero, switch parameter 2 must be on

### NCR 2151 & 2152

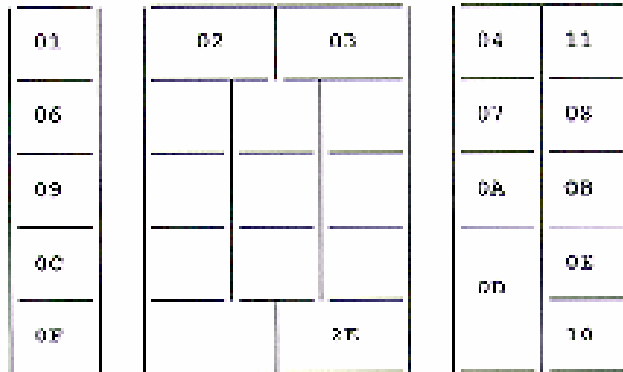



## Keyboard Functions Supported

A = Hex Code

B = Keyboard Function Code

C = Keyboard Function Record

A	B	C
00	\$U	#00
01	\$A	#01
02	\$B	#02
03	\$C	#03
04	\$D	#04
05	\$E	#05
06	\$F	#06
07	\$G	#07
08	\$H	#08
09	\$I	#09
0A	\$J	#10
0B	\$K	#11
0C	\$L	#12
0D	\$M	#13
0E	\$N	#14
0F	\$O	#15
10	\$P	#16
11	\$Q	#17
12	\$R	#18
13	\$S	#19
14	\$T	#20
15	4U	#21
16	\$V	#22
17	\$W	#23
18	\$X	#24
19	\$Y	#25
1A	\$Z	#26
1B	%A	#27
1C	%B	#28
1D	%C	#29
1E	%D	#30
1F	%E	#31

### NCR 2154 & 2155

01	02	03	04		29	06	07	08
09	0A	0B	0C		0E	0F	10	11
12	13	14	37	30	39	15	16	17
18	19	1A	34	35	36	00	1B	1C
1D	1E	1F	31	32	33	20	21	22
23	24	25	30		26		27	28

### NCR 2151 & 2152

01	02		03	04
05				06
07				08
09				
				0A

## Keyboard Functions Supported

A = Hex Code

B = Keyboard Function Code

C = Keyboard Function Record

A	B	C
00	\$U	#00
01	\$A	#01
02	\$B	#02
03	\$C	#03
04	\$D	#04
05	\$E	#05
06	\$F	#06
07	\$G	#07
08	\$H	#08
09	\$I	#09
0A	\$J	#10
0B	\$K	#11
0C	\$L	#12
0D	\$M	#13
0E	\$N	#14
0F	\$O	#15
10	\$P	#16
11	\$Q	#17
12	\$R	#18
13	\$S	#19
14	\$T	#20
15	4U	#21
16	\$V	#22
17	\$W	#23
18	\$X	#24
19	\$Y	#25
1A	\$Z	#26
1B	%A	#27
1C	%B	#28
1D	%C	#29
1E	%D	#30
1F	%E	#31

### NCR 2154 & 2155

61	62	63	64	65	66	67
68	69	6A	6B	6C	6D	6E
6F	70	71	72	73	74	75
16	17	07	09	11	01*	76
18	19*			10*	15	77*
1A*	1B			0F	14*	78
1C	1D*			0E*	13	79*
1E*	1F	0A*	0C	0D	12*	7A

### NCR 2151 & 2152

3X	31	40	23	24	25	4K	26	2A	2R	29	5P	2A	08
60	31	32	33	34	35	36	37	38	39	30	2D	3D	5C
0B	51	57	45	52	54	55	49	4F	50	70	7D	7C	5C
	51	53	64	66	67	68	6A	6B	6C	3A	22	0D	
	5A	5D	43	56	42	48	4D	3C	38	3F			
	7A	7B	63	76	62	6E	6D	2C	2E	2F			

NCR 7052 - CONTROL KEYPAD

						7P	02	03
						7R	04	06

NCR 7052 - POS KEYPAD

1A	17	07	09	11	01*
18	19*			13*	15
1A*	1B			0F	14*
1C	1D*			0E*	13
1E*	1F	0A*	0C	0D	12*

#### \* Denote Blocking Keys –

If the Blocking Keys are used with a double key cap in association with another key, the key corresponding to the "\*" Function Codes must not be used.

## Keyboard Functions Supported

A = Hex Code

B = Keyboard Function Code

C = Keyboard Function Record

A	B	C
00	\$U	#00
01	\$A	#01
02	\$B	#02
03	\$C	#03
04	\$D	#04
05	\$E	#05
06	\$F	#06
07	\$G	#07
08	\$H	#08
09	\$I	#09
0A	\$J	#10
0B	\$K	#11
0C	\$L	#12
0D	\$M	#13
0E	\$N	#14
0F	\$O	#15
10	\$P	#16
11	\$Q	#17
12	\$R	#18
13	\$S	#19
14	\$T	#20
15	4U	#21
16	\$V	#22
17	\$W	#23
18	\$X	#24
19	\$Y	#25
1A	\$Z	#26
1B	%A	#27
1C	%B	#28
1D	%C	#29
1E	%D	#30
1F	%E	#31

### NCR 280

01	02	03	04
0B			06
07			08
09			
			0A

### TEC M2300-41

	02	03	04		
18	06	07	89	24	
	09	10	11	12	25
19	13	01	14	26	
20	15			27	
21	16			28	
22	17			29	
23			30		

## Keyboard Functions Supported

**A = Hex Code**

**B = Keyboard Function Code**

**C = Keyboard Function Record**

A	B	C
00	\$U	#00
01	\$A	#01
02	\$B	#02
03	\$C	#03
04	\$D	#04
05	\$E	#05
06	\$F	#06
07	\$G	#07
08	\$H	#08
09	\$I	#09
0A	\$J	#10
0B	\$K	#11
0C	\$L	#12
0D	\$M	#13
0E	\$N	#14
0F	\$O	#15
10	\$P	#16
11	\$Q	#17
12	\$R	#18
13	\$S	#19
14	\$T	#20
15	4U	#21
16	\$V	#22
17	\$W	#23
18	\$X	#24
19	\$Y	#25
1A	\$Z	#26
1B	%A	#27
1C	%B	#28
1D	%C	#29
1E	%D	#30
1F	%E	#31

### DTS – 55 Keys

BL	19	0E	03	2F	28	20			
29	22	1B	0C	24	1C	15	3E	06	2C
3A	2A	10	37	38	39	1D	2D	26	1E
04	3B	*	34	35	36	11	*	14	16
0F	08	07	31	32	33	12	3F	BL	*
1A	3C	BL	30	2B	3D	09	25	0A	BL

### DTS – 63 Keys

01	02	03	04	05	06	07	08	09	0A	0B
0C	0D	0E	0F	10	11	12	13	14	15	16
17	18	19	1A	1B	1C	37	38	39	1D	1E
1F	20	21	22	23	24	34	35	36	25	26
27	28	29	2A	2B	2C	31	32	33		2D
2E	2F	3A	3B	3C		30	3D	3E		3F

**Appendix E: RS 232 AUXILIARY PORT  
- TECHNICAL SPECIFICATIONS**

This appendix provides information for connecting devices to the RS 232 Auxiliary Port of the unit.

The port receptacle will receive an AMP - [RJ] plug: Defined as a 6 position, 6 contact connector.

The RS 232 Auxiliary Port can support ASCII, Asynchronous, Serial communications.

The RS 232 Auxiliary Port provides an external serial interface with the following communications port (pin out) definitions:

1 = GND	ground line	
2 = TXD	transmit data line	Output
3 = RXD	receive data line	Input
4 = CTS	clear to send line	Output
5 = RTS	request to send line	Input
2 = TTL	level solicit	Output

The RS 232 Auxiliary Port is programmed with the following capabilities and constraints.

- A data record (label) can start with any ASCII data.
- A data record can include any data in the ASCII character set 00h thru 7Fh. The unit will delete characters not included in this character set from the incoming data record.
- A data record must end with a Record Terminator.  
**NOTE:** The record terminator selected will **NOT** be transmitted to the terminal. Its only function is to signal the end of a record.
- A data record (label) can contain or consist of one or more keyboard record function codes. Keyboard function codes can be embedded in any position within the data record.
- If Keyboard Functions are being sent to the terminal, the parameter "Functions Codes" for the Serial Port must be enabled.
- A Preamble or Postamble may be attached to the record being uploaded.
- An edit can be programmed for the RS 232 input record to both validate and reformat the data prior to output transmission. See Appendix C for further information about key codes.
- Record length can not exceed 64 characters.

## Appendix F: RS 232 INPUT - DATA TRANSFER DEFINITIONS

The protocol selections are designed to accommodate two basic forms of data transfer - Record and Automatic/Operator Controlled Upload.

- **PROTOCOL = RECORD**

The first data transfer method is termed Record Protocol. This protocol is used when scales or other readers are connected to the auxiliary port. These devices send data in a record format. The data is buffered by the unit until the End of Record is received. Once received, the data record will be transmitted to the terminal.

If Input Inhibit is NOT being checked, the operator must take responsibility for pacing the input to make sure that the terminal is available for data entry. This is true for all protocol options.

See Appendix A: "Interfaces" for terminals that support Input Inhibit, and Appendix G: "Input Inhibit Considerations" for the installation of the Input Inhibit cable when necessary .

1.      **TRANSFER METHOD =            RECORD**  
          **PROTOCOL =                    READY**

Terminals Supported:    ALL  
Maximum Record Size:   64  
Record Terminator:      Programmed (00H-7FH)

**NOTE:**

The Record Terminator is only used to signal the end of data. Data will not be transmitted to the screen until the Record Terminator is received. The Record Terminator itself will not be transmitted to the screen. If Keyboard Functions are being sent to the terminal, the parameter "Function Codes" for the Serial Port must be enabled.

A Preamble, Postamble or an Edit can be programmed for the RS 232 input record to both validate and reformat the data prior to output transmission.

2.      **TRANSFER METHOD =            AUTOMATIC/OPERATOR**  
          **CONTROLLED UPLOAD**

The second type of data transfer is covered by the remaining protocols (Solicit, Burst, ACK) These are used for uploading data from portable devices.

For a automatic upload Input Inhibit MUST be checked and the portable must be able to recognize a DC1 for Solicit or a DC1/DC3 for Burst. Another possibility is if the portable can be controlled by the CTS line in Burst.

If Input Inhibit is NOT being checked, each block of data must be transmitted by an Operator Controlled Operation on the portable.

For further information on Input Inhibit, reference Appendix A: "Interfaces" and Appendix G: "Input Inhibit Considerations".

The Serial Port Preamble and Postamble are used to aid in the control of the data being uploaded.

**Preamble:**

If defined a Start of Block Character **MUST** be sent before any data buffering will take place. The character defined will be expected for each block.

**Postamble:**

Three positions can be defined.

**Position 1: Record Postamble**

If defined, the character will be appended to the end of each record. An entry of "00" (Zero, Zero) will Null any position.

**Position 2: End of Block Character**

Default = "ETX" (03h)

**Position 3:** Determines whether the **transmit command** will be issued at the end of a block.

Default = "Y" (59)

3. **TRANSFER METHOD = AUTOMATIC UPLOAD**  
**PROTOCOL = XON**

Terminals Supported: Only those that support Input Inhibit checking. Check Appendix A: "Interfaces".

The connecting unit must be able to respond to a "DC1" (i.e. XON).

Device controlled block size. Data records must be sent in a fixed record count, separated by a end of record character. The blocking factor cannot exceed the limitation of the terminal screen it is being sent to (Maximum characters per block = 1500).

Each block of data must be terminated by a End-of-Text (ETX = 03h) character.

To signal the transmission of the last block of data from the device, the last block of data is terminated by End-Of-Transmission (EOT), End-Of-Text (ETX). Or, a block of data can be sent containing just the End-Of-Transmission (EOT) character.

After the first block of data is received the unit will solicit the subsequent blocks by sending a DC1 (11h) to the device. The device must wait for the DC1 before sending any subsequent blocks.

Upon receiving the End-Of-Text (ETX) the unit will automatically transmit the block to the terminal, "Screen", and issue "ENTER" to transmit to the host CPU before it solicits the next block of data.

If Keyboard Functions are being sent to the terminal, the parameter Functions Codes for the Serial Port must be enabled.

See Page F-2 for Postamble and Preamble definitions.

## Sequence of Events For Portable Device Automatic Upload to a Terminal

### Portable

### Wedge

Operator sends 1 <sup>st</sup> block of data (ETX) or Portable responds to DC1	◀ Sends DC1 until data is received
Device Sends Block 2 (ETX)	▶ Sends Block 1 to the terminal ◀ Sends DC1 until data is received
Device Sends Block n (ETX) or (ETX)	▶ Sends Block 2 to the Terminal ◀ Sends DC1 until data is received
Device sends (EOT) or nothing if (EOT) Device Was sent with Block n	▶ Sends Block n to the Terminal ◀ Sends DC1 ▶ Ends communication with the Portable  by audible alerts to the operator of upload completion.

**4.      *TRANSFER METHOD =                      OPERATOR CONTROLLED UPLOAD***  
***PROTOCOL =                                SOLICIT***

Terminals Supported: ALL

During the transmission of data to the terminal the operator will monitor the terminal for input inhibit restriction. By doing so, no data should be lost.

All blocks of data sent must be initiated by the operator. Therefore, the connecting unit must be able to respond to an operator command entered on it.

Device controlled block size. Data records must be sent in a fixed record count, separated by an end-of-record character. The blocking factor cannot exceed the limitation of the defined terminal screen.

Each block of data must be terminated by a End-Of-Text (ETX = 03h) character.

To signal the transmission of the last block of data from the device, the last block of data is terminated by End-Of-Transmission (EOT), End-Of-Text. Or, a block of data can be sent containing just the End-Of-Transmission (EOT) character.

Upon receiving the Record Terminator the unit will automatically transmit the block to the terminal "Screen", and issue "ENTER" to transmit to the host CPU before it solicits the next block of data.

If Keyboard Functions are being sent to the terminal, the parameter Functions Codes for the Auxiliary Port must be enabled.

See Page F-2 for Postamble and Preamble definitions.



## Sequence of Events for Portable Device Using Operator Controlled Upload to a Terminal

### Portable

### Wedge

Portable Ignores DC1	◀	Sends DC1 until data is received
Operator Sends 1st Block of Data (ETX)	▶	Sends Block 1 to the terminal
Portable Ignores DC1	◀	Sends DC1 until data is received
Operator Sends Block 2 (ETX)	▶	Sends Block 2 to the Terminal
Portable Ignores DC1	◀	Sends DC1 until data is received
Operator Sends Block n (ETX) or (EOT ETX)	▶	Sends Block n to the Terminal
Portable Ignores DC1	◀	Sends DC1
Operator Sends (EOT) or nothing if (EOT) was sent with Block n	▶	Ends communications with the Portable Device by audible alerts to the operator of upload completion.

**5.      *TRANSFER METHOD =                    AUTOMATIC UPLOAD***  
***PROTOCOL =                            BURST***

Terminals Supported: Only those that support Input Inhibit checking. Check Appendix A: "Interfaces". During the transmission of data to the terminal the unit will monitor the terminal for input inhibit restriction. By doing so, no data will be lost in the event that the terminal is inhibited.

The connecting unit must be able to respond to a "DC1" and "DC3" (i.e. XON, XOFF), and to the raising and lowering of the "Clear To Send" (CTS) line.

The wedge controls the size of the block being sent to the terminal. Once 1500 characters have been received the wedge will issue a XOFF and drop CTS. The first block of data sent must be initiated by the operator. After the first block of data is received the wedge will control the flow of subsequent blocks. Upon receiving the 1500 characters the wedge will:

- 1) issue an XOFF and drop CTS
- 2) automatically transmit the block of data to the terminal "Screen"
- 3) automatically transmit to the host CPU
- 4) Raise Clear-To-Send (CTS)
- 5) Issue an XON for the next burst of data

The last block of data is terminated by End-Of-Transmission (EOT).

If Keyboard Functions are being sent to the terminal, the parameter Functions Codes for the Auxiliary Port must be enabled.

See Page F-2 for Postamble and Preamble definitions.

**NOTE:**

It is recommended that when sending data in this mode, that an Intercharacter Delay be set in the portable device to insure that the device does not "miss" any XOFF instructions before sending any data. This will help to prevent any loss of data on a character-to-character transmit basis.

**6.      *TRANSFER METHOD =            RECORD***  
***PROTOCOL =                    ACK***

When programmed for ACK protocol, the unit will receive data in two transfer modes. One will be Single Records, the other a block type mode consisting of multiple records. The controlling parameters will be the Auxiliary Port Preamble and Postamble selections.

***Preamble:***        Defines the Start of Block Character.  
                      No data will be buffered until the Preamble is received. Default (not defined) = NO  
                      Start of Block Character will be expected.

***Postamble:***        Three positions for controlling data.  
                      **1** = A Postamble to be appended to the end of each record.  
                      **2** = Character that defines the end of block. If not assigned a value, Record Mode is active (each record represents a block).  
                      **3** = Enter the character "Y" (Yes) or "N" (No) to indicate if the Enter/Transmit command is to be sent at the end of each block.

With the Record Mode active, the unit receives data in single records. A record may contain up to 1500 bytes, including the Record terminator. After receipt, the record will be transmitted to the terminal, and an ACK (06h) will be sent to the connected device. The device is now allowed to send another record.

The use of the Second Postamble Character, activates ACK Block Mode. Whereby, an ACK (06h) is sent to the connected device after each record is received. The records are buffered until the defined postamble code is received. This code is NOT ACKed. The records stored will be transmitted to the terminal and an "Enter" will be issued at the end of block. An ACK will then be sent to the connected device. The device can then begin another transfer.

The standard programming rules are in effect for all other parameters.

**Sequence of Events for Portable Device Upload Using Record Mode - ACK Protocol**

<b>TERMINAL</b>	<b>WEDGE</b>	<b>RS 232 CONNECTED DEVICE</b>
		◀ 1st Rec. (EOR) device initiates transmission
	◀ Receives and buffers record. Sends Rec. to Terminal. If 1 <sup>st</sup> character of Postamble is defined, it is transmitted.	
	Sends ACK (06h) *	▶ After receiving ACK, the device may transmit next record (if any)
		◀ Device sends nth Rec. (EOR) (if any)

Loop back to Step 2.

This sequence is repeated until all records are sent from connected device.

**Sequence of Events for Portable Device Upload Using Block Mode ACK Protocol**

<b>TERMINAL</b>	<b>WEDGE</b>	<b>RS 232 CONNECTED DEVICE</b>
		◀ 1st Rec. (EOR) device initiates transmission
	Receives and buffers record. Sends ACK (06h)	▶ ACK is received.
	Repeat ACK (06h) for each record until the End of Block (EOB) character is received.	◀ Device transmits next record. ◀ Device sends nth Rec. (EOR)
	Receives Record and/or (EOB)	◀ Device sends Record, (EOR), (EOB) or (EOB) by itself
◀	All stored records are transmitted to the terminal, at the end of the block a "Enter" command will be sent to the terminal. (See Postamble).	
	Sends ACK to the device to signal it to begin transmitting again.	▶

Loop back to Step 4

## Appendix G: INPUT INHIBIT CONSIDERATIONS

The following pages describe the operation of the unit relevant to each terminal type supporting "Input-Inhibit", which when monitored will prevent the loss of data from the unit to the terminal and in turn to the host CPU. In most terminal environments, the terminal is often "inhibited" from sending data to the host CPU. This can happen just after a screen, or "page" of data is sent to the host CPU by the operator activating the "XMIT", "REC ADV", or "ENTER" key at the keyboard. Further input from the keyboard is ignored by the terminal, as long as input is inhibited by the host CPU. The Input-Inhibited condition is usually indicated to the operator by a visual indicator on the terminal screen.

Because the unit emulates the operator's action of sending data to the host CPU and in turn cause an input-inhibited condition, this condition must be monitored by some means other than a visual indicator. Described on the following pages are some operator "rules" and hardware installation procedures required for each terminal supported.

Input-inhibited monitoring is accomplished only if the unit has been programmed to do so. Refer to the "GENERAL I" programming menu for programming Input Inhibit.

Unless the terminal type is specified in this appendix, the unit will **NOT** monitor Input Inhibit regardless of how the parameter is set.

### **DECISION DATA: 3761, 3791**

The unit will monitor Input Inhibit if the unit has been programmed for this parameter to be ON and the ENTER command is issued.

**IBM :** 3179-1  
**TELEX:** 078, 079, 080, 179, 180, 191

After power, the Input Inhibit parameter must be selected. Also, the keyboard clicker "on/off" key can not be used by the operator.

However, if Input Inhibit is not being monitored, this clicker key is available to the operator.

### **IBM: 3180-1, 3180-2**

If Input Inhibited is to be monitored, the Intercharacter Delay parameter must be set to 02 and a jumper cable must be installed inside the terminal. The following sequence describes the installation.

1. Remove the logic element from the IBM 3180. Move the lever on the lower-left, rear corner of the terminal to the "OPEN" position. Push the two locking bars at the right side of the logic element forward. Hold the logic element and swing the right side out. Remove the two left latches from the display element.
2. View the logic element with the PC board face up. Attach the spring clip end of the single wire cable (ordered with the standard interface cable) to the right terminal of the speaker.
3. Thread the unattached end of the single wire cable through one of the slots at the bottom of the logic element, making certain that the cable will not interfere with the reinstallation of the logic element.
4. Install the logic element on the display element.

5. Connect the single wire receptacle, from the bottom of the element, to the single wire plug from the terminal end of the interface cable ordered with the unit.

**NOTE:**

You must disconnect the single wire cable at the plug and receptacle junction if the unit is removed from the IBM 3180 terminal, but need not remove it from the logic element.

6. The operator must turn the keyboard clicker on and the clicker volume to a medium to high level (refer to the IBM 3180 users manual "set-up" procedures).
7. The hardware installation to monitor Input-Inhibit is now complete.

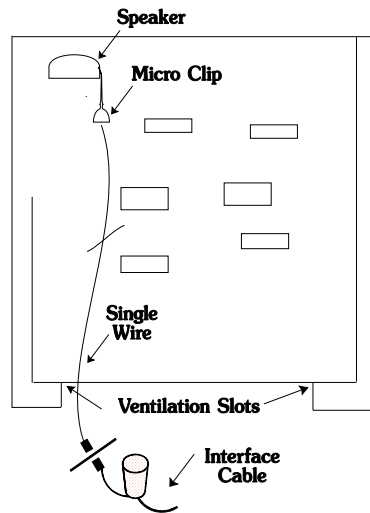

**IBM 3180: Input Inhibit Installation**

**IBM: 3179-2**

If Input Inhibited is to be monitored, a jumper cable must be installed inside the terminal. The following sequence describes the installation.

1. Remove the logic element from the IBM 3179-2. Refer to the IBM 3179 Model 2 Problem Solving Guide, Steps 1 through 7 of "Logic Element Removal" procedures.
2. Open the logic element by removing the hex head screw from the bottom center of the logic element case. Next push in the tabs at the front of the case and lift the top from the logic element case.
3. View the logic element with the PC board face up. Attach the "spring clip" end of the single wire cable (ordered with the standard interface cable) to pin 9 on the chip at board location ZM22. Pin 9 is the sixth pin from the top (notched end) of the chip on the right side.
4. Thread the unattached end of the single wire cable through the hole at the back of the logic element, next to the monitor connector, making certain that the cable will not interfere with the reinstallation of the logic element.
5. Install the logic element on the display element.

6. Connect the single wire receptacle, from the back of the logic element, to the single wire plug, from the terminal end of the interface cable, ordered with the unit.

**NOTE:**

You must disconnect the single wire cable at the plug and receptacle junction if the unit is removed from the IBM 3179-2 terminal, but need not remove it from the logic element.

7. The operator must turn the keyboard clicker on and the clicker volume should be set to a mid to hi level. Refer to the IBM 3179-2 users manual "set-up" procedures.
8. The hardware installation to monitor Input-Inhibit is now complete.

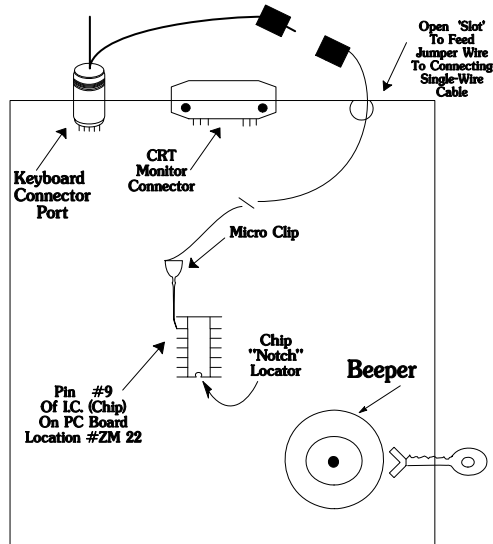

**IBM 3179-2: Input Inhibit Installation**

**IBM: 3196**

If input inhibited is to be monitored, a jumper cable must be installed inside the terminal. The following sequence describes the installation.

1. Remove the logic element from the IBM 3196. Refer to IBM 3196 Display Problem Solving Guide, "logic Element Removal" section.
2. Open the logic element by pressing a flathead screw driver in the 4 slots at the corners on the bottom of the logic element.
3. View the logic element with the PC Board face-up and the front of the logic element facing you. Attach the spring clip end of the single wire cable (ordered with the standard interface cable) to pin 1 on the clip at board location U-7. Pin 1 is the first pin from the notched end of the chip on the right side.
4. Thread the unattached end of the single wire cable through one of the grid holes at the bottom of the logic element near the front of the unit, making certain that the cable will not interfere with the installation of the logic element.

5. Place the logic element cover back on and install the display on the logic element by following the "logic element replacement" procedures on the IBM 3196 Display Station Problem Solving Guide.
6. Connect the single wire receptacles from the front of the logic element to the single wire plug, from the terminal end of the interface cable, ordered with the unit.

**NOTE:**

You must disconnect the single wire cable at the plug and receptacle junction if the unit is removed from the IBM 3196 terminal, but need not remove it from the logic element.

7. The operator must turn on the keyboard clicker and set the clicker volume at levels 2, 3, or 5. To determine the clicker volume level, refer to IBM 3196 manual on clicker volume set-up. We refer to no clicker volume as level 0. Each time you press the F5 key to increase volume, it is increased by 1. The highest clicker volume would be level 5.
8. The hardware installation to monitor input-inhibit is now complete.

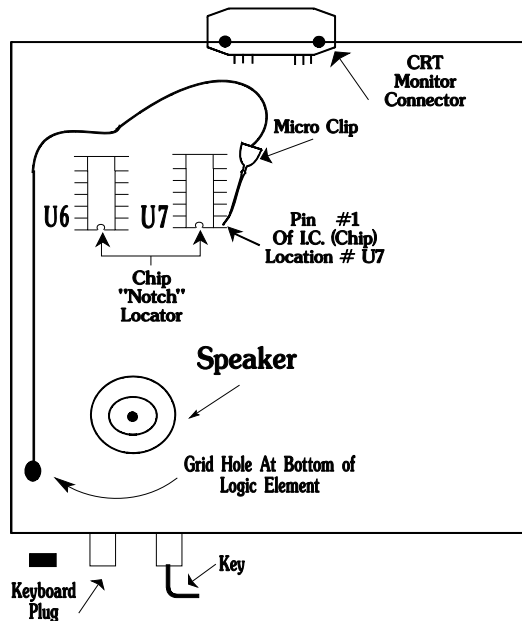

**IBM 3196: Input Inhibit Installation**

**IBM: 3481, 3486**

If Input Inhibited is to be monitored, a jumper cable must be installed inside the terminal.

After this cable is installed, Input Inhibit can be monitored only if the unit is programmed for this function.

The following sequence describes the installation.

1. Insure that the IBM 3481/3486 terminal is powered off and the AC power is disconnected.
2. Extract the monitor from the cabinet by removing the 2 torque type screws from the bottom of the unit. Insert a long, flat instrument (ideally with a point) int the 2 small slots on the top-back of the cabinet. Using a slight amount of pressure, pry the internal catches downward and pull back on the cabinet.

3. After reviewing the following drawing, locate Transistor Q503 on the PC Board. Attach the single wire cable (ordered with the standard interface cable) spring clip end to the base leg of this transistor. (the leg opposite the one labeled on the PC board with an "E"). Reference Drawing.
4. Thread the single wire cable between the PC Board and the plastic shield located along the right hand side of the PC Board.
5. Re-Install the cabinet and thread the single wire cable through one of the air vents on the side of the cabinet.
6. Attach the single wire receptacle to the wire plug protruding from the interface cable (8 pin plug) that attaches to the terminal.
7. Complete the installation of the reader by programming the following:
 

3481 & 3486	Input Inhibit = <b>ON</b>
3486 Only	Intercharacter Delay = <b>02</b>
8. The IBM 3481/3486 must be configured with the following parameters set using the ON-Line Set-up.
 

Clicker =	OFF (3481)	ON (3486)
Volume =	1-4 (3481 & 3486)	
1. The hardware installation to monitor Input-Inhibit is now complete.

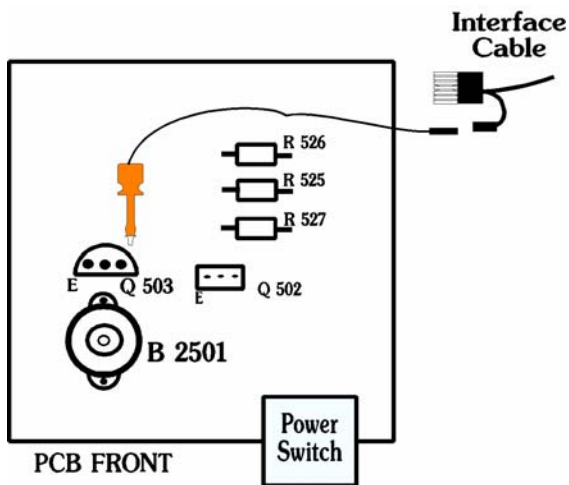

**IBM 3481& 3486: Input Inhibit Installation**



## Appendix H: SERVICE AND REPAIR

The unit carries a 1 year warranty. The specific warranty language is contained in the Appendix I of this manual.

Factory service is also available on a time and material basis for out-of-warranty products. If you use this mode of service you will be advised of a not-to-exceed price for repair when you request a Return Material Authorization (RMA) for the product.

Products may be returned for repair by requesting a Return Material Authorization (RMA) from Compsee Customer Service.

**1-321-724-4321 or 1-800-628-3888**

When calling Compsee Customer Service you should be prepared with the following information.

- Model Number
- Serial Number
- Accurate Description of the Problem
- Company Name (Being Sent From)
- When and How it is being Sent)
- Return to Address
- Contact Name and Telephone Number

This information is necessary for us to complete an RMA for the product. **We cannot accept materials that are returned without an RMA number.** This number will insure that the problem described is corrected and the unit is repaired and returned in a timely fashion.

Normal Repair time is 10 days from receipt of equipment.

Warranty Repairs: The user pays for the shipping of the equipment to Compsee. Compsee will pay for return shipping in the same manner that the equipment was shipped to Compsee, for warranty repairs.

Non-Warranty Repairs: The (user) will pay shipping both ways, to and from the service center.

## Appendix I: WARRANTY TERMS

Compsee (**COMPSEE**) warrants that its products will be free of defects in workmanship and material for a period of one (1) years the lifetime from the original shipment date when subject to normal use and service. The warranty is extended to the original end-user owner of the equipment. This warranty does not cover any **COMPSEE** equipment which is

- (i) improperly installed or used
- (ii) damaged by accident or neglect, including failure to follow the proper maintenance, service and cleaning schedule
- (iii) damaged as a result of
  - (A) modification or alteration by the purchaser
  - (B) excessive voltage or current supplied to or drawn from the interface connections
  - (C) operation under conditions beyond the specified operating parameters
  - (D) repair or service of the equipment by anyone other than **COMPSEE** or its authorized representatives.

In the event of failure of equipment covered by this warranty, **COMPSEE** will repair such equipment returned (at customer expense) to its factory at Mt. Gilead, North Carolina, USA, within 1 year of original shipment date, provided that inspection by **COMPSEE** or a **COMPSEE** Authorized Independent Service Facility determines to its satisfaction that the equipment was defective due to defects in materials or workmanship. **COMPSEE** may, at its option, replace the equipment or subassembly in lieu of repair. Defective equipment, returned within five years of the original shipment date, will be repaired or replaced without charge, except for return shipping to **COMPSEE**, unless the failure was caused by misuse, neglect, accident, abnormal operating conditions, improper modification or alteration of the equipment, or repair or service of the equipment by anyone other than **COMPSEE** or its authorized representatives, in which case the repairs will be billed at the material and labor rates prevailing at the time of repair. In such case, a not-to-exceed repair estimate will be submitted before work is started, if requested.

No products will be accepted by **COMPSEE** or its Authorized Service Facilities without a Return Materials Authorization, which may be obtained by contacting the factory. In the event that the defective product cannot be repaired or replaced within a reasonable period of time **COMPSEE**'s sole obligation under this warranty shall be to refund the price paid, less tax and transportation.

### **LIMITATIONS**

**EXCEPT AS MAY BE OTHERWISE PROVIDED BY APPLICABLE LAW, THE FOREGOING WARRANTY IS IN LIEU OF ALL OTHER COVENANTS OR WARRANTIES, EITHER EXPRESSED OR IMPLIED, ORAL OR WRITTEN, INCLUDING WITHOUT LIMITATION, ANY IMPLIED WARRANTIES OF MERCHANTABILITY OR FITNESS FOR A PARTICULAR PURPOSE. SOME STATE, PROVINCES, OR COUNTRIES DO NOT ALLOW DISCLAIMERS OR LIMITATIONS OF IMPLIED WARRANTIES, SO THE ABOVE DISCLAIMER AND LIMITATION MAY NOT COMPLETELY APPLY TO YOU.**

**COMPSEE'S RESPONSIBILITY AND PURCHASER'S EXCLUSIVE REMEDY UNDER THIS WARRANTY IS LIMITED TO THE REPAIR OR REPLACEMENT OF THE DEFECTIVE PRODUCTS. ANY PROVISION HEREIN TO THE CONTRARY NOTWITHSTANDING, COMPSEE SHALL NOT BE LIABLE FOR INDIRECT, INCIDENTAL OR CONSEQUENTIAL DAMAGES, AND IN NO EVENT SHALL ANY LIABILITY OF COMPSEE ARISING IN CONNECTION WITH ANY PRODUCTS SOLD HEREUNDER (WHETHER SUCH LIABILITY ARISES FROM A CLAIM BASED ON CONTRACT, WARRANTY, TORT, OR OTHERWISE) EXCEED THE ACTUAL AMOUNT PAID TO COMPSEE FOR THE PRODUCTS. SUCH LIMITATIONS IN LIABILITY SHALL REMAIN IN FULL FORCE AND EFFECT EVEN WHEN COMPSEE MAY HAVE BEEN ADVISED OF THE POSSIBILITY OF SUCH INJURIES, LOSSES OR DAMAGES. SOME STATES ALLOW THE EXCLUSION OR LIMITATION OF INCIDENTAL OR CONSEQUENTIAL DAMAGES, SO THE ABOVE LIMITATION OR EXCLUSION MAY NOT APPLY TO YOU.**

**COMPSEE SHALL NOT BE HELD RESPONSIBLE OR LIABLE IN ANY WAY FOR THE FAILURE TO SELL OR DELIVER ANY PRODUCTS HEREUNDER DURING A PERIOD IN WHICH SUCH SALE AND DELIVERY ARE PREVENTED OR HINDERED BY ANY CAUSE BEYOND COMPSEE'S REASONABLE CONTROL.**

**COMPSEE IS NOT RESPONSIBLE FOR DAMAGE TO THE PRODUCT OR EQUIPMENT INCURRED DURING THE SHIPMENT. ANY CLAIMS FOR SHIPPING DAMAGE SHOULD BE MADE DIRECTLY TO THE CARRIER.**

**NO COMPSEE AGENT, EMPLOYEE, OR REPRESENTATIVE HAS THE AUTHORITY TO MAKE OR IMPLY ANY REPRESENTATION, PROMISE OR AGREEMENT WHICH IN ANY WAY VARIES THE TERMS OF THIS LIMITED WARRANTY.**

All of the provisions of this Limited Warranty are separate and severable, which means that if any provision is held valid and unenforceable, such determination shall not affect the validity or enforceability of the other provisions hereof.

**This Limited Warranty gives the purchaser specific legal rights and the purchaser may also have other rights which vary from state-to-state, province-to-province, or country-to-country.**