

# QuickLink™ 501 & 601



**Manual #: 02CO033**

## Installation and Operations Manual

Part Number: **02CO033**  
Printed: **01/00**  
Revision Level: **QL501 = 501.07, QL601 = 601.07**

**Copyright by COMPSEE**

### **Warning**

Changes or modifications to this unit not expressly approved by the party responsible for compliance could void the user's authority to operate the equipment.

### **Notes**

This equipment has been tested and found to comply with the limits for Class A digital device, pursuant to Part 15 of the FCC Rules. These limits are designed to provide reasonable protection against harmful interference when the equipment is operated in a commercial environment. This equipment generates, uses and can radiate radio frequency energy and, if not installed and used in accordance with the instruction manual, may cause harmful interference to radio communications. Operation of this equipment in a residential area is likely to cause harmful interference in which case the user will be required to correct the interference at his own expense.

## QUICK START

The following Quick Start Installation procedure will handle 95% of the keyboard wedge installation. If your cabling and hook-up do not conform to the instructions below, please consult the Programming Manual.

### INSTALLATION

1. **TURN OFF POWER TO THE TERMINAL TO WHICH THE READER WILL BE CONNECTED.**
2. Locate the "Y" interface cable. Plug the cable housing into the back of the unit. Once plugged in the cable housing should be flush with the unit.
3. Disconnect the keyboard cable from the keyboard port and plug it into the short leg of the "Y" cable.
4. Plug the long leg of the "Y" cable into the terminal's keyboard port.
5. Plug in the scanning device.
6. If an external power supply is required, Plug it into the receptacle located on the back of the unit. Then plug the power supply into a power source.
7. Turn on the power to the terminal.
8. **PROGRAM FOR TERMINAL TYPE**  
**IMPORTANT:** If this is a first time installation, it is NECESSARY\_ to program the unit for use with the connected terminal. Proceed as follows:
  - Using the TERMINAL TYPE programming menu, scan the **ENTER** bar code symbol.
  - Scan the two (2) digits on the BAR CODE CHART which corresponds to the two (2) digit code listed for the specific terminal.
  - Scan the **EXIT** bar code symbol.
9. Scan the following bar code to verify communications to the terminal.



### 10. PROGRAMMING FOR ADDITIONAL PARAMETERS

Use the remaining programming sheets, i.e. GENERAL I, GENERAL II, SERIAL I, SERIAL II, SERIAL III, SCANNER PORT, INDUSTRIAL CODES, RETAIL CODES, EDIT and KEYBOARD REMAP to complete the programming.

#### **EXAMPLE:** Return Key After Each Bar Code

- Scanner Port Menu  
Scan: Enter  
Scan: Postamble
- Bar Code Chart  
Scan: 0D
- Scanner Port Menu  
Scan: Exit

**NOTE:** Each sheet has default parameters associated with it which are indicated by asterisks "\*" on the programming menus.

To assign these DEFAULT parameters,

- scan the ENTER symbol
- scan the DEFAULT symbol
- scan the EXIT symbol

If Default parameters are not desired,

- scan the ENTER symbol
- scan the desired parameter
- scan the letter/digit combination listed on the programming sheet
- scan EXIT

*After the EXIT symbol is scanned, the program information is stored in non-volatile memory and will not have to be programmed again unless changes are desired.*

## Table of Contents

<b>I.</b>	<b>Introduction</b>	
	Output Options	Keyboard Wedge 7
		RS 232 7
	Input Options	Bar Code 8
		Magnetic Stripe 8
		RS 232 8
	Standard Specifications	Dimensions 8
		Current Draw 8
		DC Voltage 8
		Environmental 9
		Electrical 9
		Scanning Speed 9
<b>II.</b>	<b>Installing the Reader - Keyboard Wedge</b>	
	Installation	10
	Connecting the Scanning Device	10
	Connecting an RS 232 Device	10
	Connecting a Magnetic Stripe Reader	10
	Terminal Power Up Sequence	10
	Programming For Terminal Type	10
	Programming Additional Parameters	11
<b>III.</b>	<b>Installing the Reader - POS Terminals</b>	
	NCR 280 – Non-Buffered Keyboard	12
	NCR 280 – Buffered Keyboard	12
	NCR 2151	12
	NCR 2152	13
	NCR 2154/2155	13
	NCR 7052	14
	IBM 3653	14
	IBM 4683	16
	DTS 500	18
	TEC M-2300-41	18
<b>IV.</b>	<b>Installing the Reader - Dual Port RS 232</b>	
	Installation	19
	Connecting the Scanning Device	19
	Connecting a Power Supply	19
	Terminal Power Up Sequence	19
	Programming For Serial Communications	19
	Programming Additional Parameters	20

<b>V.</b>	<b>Programming the Unit</b>	
	Default All	21
	Bar Code Menus	21
	Cloning	22
<b>VI</b>	<b>General Program Selections</b>	
	Interface Selection	
	Keyboard Wedge	23
	Serial Output	23
	General Menu I	
	Beeper Volume	23
	Input Inhibit	24
	Keyboard Type	24
	Intercharacter Delay	24
	Interfunction Delay	24
	General Menu II	
	Magnetic Track/Auxiliary Port	25
	Buffering	25
	Scale Solicit Record	26
	Switches	
	Output Edited Records Only	26
	IBM 3683 – “0” vs “00” Key	26
	IBM PC/AT without Keyboard	26
	Laser with AutoSense	27
<b>VII.</b>	<b>Scanner Port Selections</b>	
	Preamble & Postamble	28
	Laser Redundancy	28
	Function Codes	
	Code Identification	28
<b>VIII.</b>	<b>Serial Input/Output Selections</b>	
	Serial I	
	Preamble & Postamble	29
	Record Terminator	29
	Intercharacter Delay	30
	Interfunction Delay	30
	Function Codes	30
	Serial II	
	Baud Rate	31
	Parity	31
	Word Length	31
	Stop Bits	31
	AUX Port Protocol	31
	Serial III	
	Dual Port	32
	Buffer Mode	32
	Protocol	32
	Transmit Data	33
	Fixed Length Message	33

<b>IX.</b>	<b>Bar Code Selections</b>	
	Codabar	34
	Code 3 of 9	34
	Interleaved 2 of 5	34
	Industrial 2 of 5	34
	Code 11	35
	Code 93	35
	Code 128	35
	Plessey	35
	Codablock	35
	UPC	35
	EAN	36
<b>X.</b>	<b>Edit Programming</b>	37
<b>XI.</b>	<b>Keyboard Remapping</b>	
	Single Character Replacement	52
	Swap Two Keys	52
	Swap Two ASCII Characters	54
	Multiple Key Function Code	54
	Set Pause Time	56
<b>XII.</b>	<b>Status Check</b>	
	General/Serial/Scanner	59
	Bar Code Configuration	60
	Edit Status	61
	Keyboard Remap Configuration	62
<b>v</b>	<b>Appendices</b>	
	A. Interfaces	63
	B. Beep Sequences	69
	C. Key Code Charts	70
	D. Keyboard Function Records	73
	E. RS 232 Auxiliary Port Specifications	82
	F. RS 232 Data Transfer Definitions	83
	G. Input Inhibit Considerations	68
	H. Service and Repair	94
	I. Limited Warranty Terms	95
<b>v</b>	<b>Figure Listing</b>	
	Keyboard Interface - Wedge	7
	RS 232 Interface - Dual Port	7
	IBM 3180 - 1/2 Input Inhibit Installation	90
	IBM 3179-2 Input Inhibit Installation	91
	IBM 3196 Input Inhibit Installation	92
	IBM 3481/3486 Input Inhibit Installation	93

## I. INTRODUCTION

The decode/interface units are designed to be used with terminals provided by most of the major terminals manufacturers.

- **Output Options**

Interfacing to the terminals can be either through the keyboard cabling or the RS 232 interface line to the host.

**Keyboard Interface:** The unit plugs in easily between the keyboard and the terminal. Data passed through the unit appears to the terminal as if it had been keyed in by an operator.

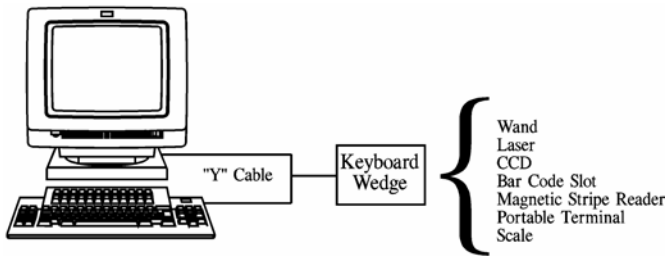

**RS 232 Serial Interface:** If the terminal communicates to its host via RS 232 cabling and communications, the unit can be interfaced between the terminal and the host on the RS 232 cable. In most cases, data is passed through the unit to the host, which in turn echoes the data to the terminal.

The RS 232 Input port can also be used as an output port to send ASCII data on a single RS 232 line.

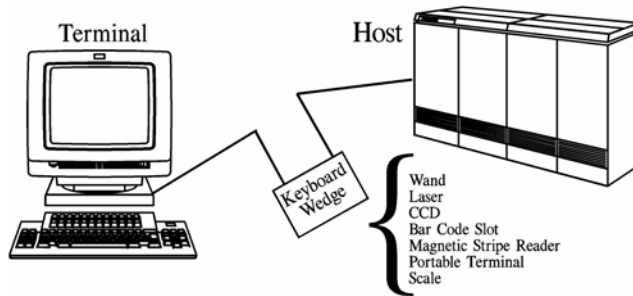

Both the keyboard and the in-line serial interfaces make it unnecessary by the user to implement any hardware or software changes in order to operate the bar code reader.

- **Input Options**

For bar code reading, a variety of input devices can be ordered that include light pens, slot readers, moving beam or fixed beam readers. With these devices, the unit is able to scan low, medium, and high density bar codes. The ability to autodiscriminate between most popular bar code symbologies is standard.

Code 3 of 9	Codabar	Interleaved 2 of 5	Industrial 2 of 5
UPC/EAN	Code 128	Code 93	Code 11
Plessey	Codablock		

The Auxiliary port can be used to input data from either an external RS 232 device or a magnetic stripe reader. It can also be used as an output port to send ASCII data on a single RS 232 line.

**Magnetic Stripe Input** – The unit can be ordered with a detached magnetic stripe reader to read tracks 1, 2 or a combination of 1 and 2.

**RS 232 Input** - ASCII data from an external reader, a scale or a portable terminal can be transmitted through the RS 232 Input Port.

**RS 232 Output** – Bar code data read via an attached scanning device can be decoded and transmitted out as ASCII data via a single RS 232 Line.

Simple user programming guarantees that data passing through the unit will appear to the software as if it had been keyed in by the operator.

The use of preamble/postamble, embedded keyboard function codes or keyboard function records allows for the operation of the terminal without manual entry from the keyboard.

Changing code parameters or disabling certain codes is accomplished by either using the bar code programming menu. The units non-volatile memory stores the user program selections.

- **Standard Specifications**

**Dimensions**

- Length 7.30 inches (185 mm)
- Width 3.40 inches (86 mm)
- Height 1.00 inches (25.4 mm)
- Weight 12 oz - Approximate weight without cable

**Current Draw**

- 70 mA at 5V
- 68 mA at 12V

**DC Voltage**

- Power source shall meet the equipment requirements for reinforced insulation according to EN 60 950:1988 (SELV)

**Stromversorgung**

- 80 mA at 5 V, 68 mA at 12V
- Gleichspannung soannungquelle muss den Isolationvorschriften EN 60 950/1988 entsprechen



**Environmental**

- Operating Temperature: +5°C to +40°C
- Storage Temperature: -20°C to +60°C
- Relative Humidity: 0% to 95% non-condensing

**Electrical**

- Keyboard Wedge Interface - Power is normally consumed from the terminal. No auxiliary power supply is required. Exceptions are noted in Appendix A.
- RS 232 Interface - The auxiliary power supply is required.

**Scanning Speed**

- Scans at 3 to 45 inches per second on standard density bar codes. Its speed range varies with code choice and density.

## II. INSTALLING THE READER - KEYBOARD WEDGE

Installation of the reader should be completed by a person familiar with installing and connecting computer systems and cabling.

### 1) INSTALLATION

1. TURN OFF POWER TO THE TERMINAL TO WHICH THE READER WILL BE CONNECTED.
2. Locate the "Y" interface cable and verify that it is the correct cable for the terminal being used.
3. Plug the cable housing into the back end of the unit. Once plugged in, the cable housing should be flush with the unit.
4. Unplug the keyboard from the terminal and re-plug the keyboard into the leg (short leg) of the "Y" cable that mates with it.
5. Plug the remaining leg (long leg) of the "Y" cable into the terminal where the keyboard was connected.
6. Arrange the fully connected unit so that all cables run fully and smoothly.

### 2) CONNECTING THE SCANNING DEVICE

Plug the scanning device into the 9 pin "D" connector on the FRONT panel.

### 3) CONNECTING THE POWER SUPPLY

Certain terminals require an external power supply. Reference Appendix A or the Genealogy Chart for the unit. If required, an **external power supply must always be used.**

Plug the external power supply into the receptacle located on the back of the unit. Then plug the power supply into a power source.

### 4) CONNECTING AN RS 232 DEVICE

If an auxiliary RS 232 input device is to be used, plug the 8 pin modular connector of the auxiliary port cable specified at the time of order into the 8 pin modular receptacle located on the FRONT panel of the unit. Connect the other end of the RS 232 cable into the output port of the RS 232 input device.

### 5) CONNECTING A MAGNETIC STRIPE READER

If a Magnetic Stripe Reader is to be used, plug the 8 pin modular connector of the magnetic stripe reader into the 8 pin modular receptacle located on the FRONT panel of the unit.

Any changes or additions desired for the Magnetic Stripe output must be programmed via the Edit Parameters.

### 6) TERMINAL POWER UP SEQUENCE

Turn ON the power to the terminal. After approximately 5 seconds the unit will beep twice. This delay is intentional and occurs so that the terminal - keyboard power on reset routines have time to complete.

## 7) PROGRAMMING FOR TERMINAL TYPE

**IMPORTANT:** If this is a first time installation, it is **NECESSARY** to program the unit for use with the connected terminal.

- Using the **TERMINAL TYPE** programming menu, scan the **ENTER** bar code symbol.
- Scan the two (2) digits on the **BAR CODE CHART** which correspond to the two (2) digit code listed for the specific terminal.
- Scan the **EXIT** bar code symbol.

**NOTE:**

After the **EXIT** symbol has been scanned, the terminal type information is stored in non-volatile memory and will not have to be programmed again unless the unit is to be connected to another terminal.

## 8) PROGRAMMING FOR ADDITIONAL PARAMETERS

Use the remaining programming sheets, i.e. **GENERAL I, GENERAL II, SERIAL I, SERIAL II, SERIAL III, SCANNER PORT, INDUSTRIAL CODES, RETAIL CODES, KEYBOARD REMAPPING** and **EDIT** to complete the programming.

**DEFAULT:** Each sheet has default parameters associated with it which are indicated by asterisks "\*" on the programming menus.

*To assign these DEFAULT parameters,*

1. scan the **ENTER** symbol
2. scan the **DEFAULT** symbol
3. scan the **EXIT** symbol

*If Default parameters are not desired,*

1. scan the **ENTER** symbol
2. scan the desired parameter
3. scan the letter/digit combination listed on the programming sheet
4. scan **EXIT**

*After the EXIT symbol is scanned, the program information is stored in non-volatile memory and will not have to be programmed again unless changes are desired.*

**INSTALLATION IS NOW COMPLETE**

### III. INSTALLING THE READER - POS TERMINALS

Installation of the reader should be completed by a technician or programmer familiar with installing and connecting systems and cabling.

- **NCR 280 - NONBUFFERED KEYBOARD**

1. Be sure the NCR 280 terminal is powered down. Remove the top cover from the terminal.
2. Locate connector M01-01 on the keyboard. Remove this cable.
3. Facing the front of the terminal, position cable # 5169-A (printed circuit board) with the component side UP and P1 to the left. Install the circuit side connector to the keyboard.
4. Install connector M01-01 to P1 on PCB # 5169-A.
5. Feed the narrow end of cable # 5169-B through a convenient slot in the rear of the terminal top cover. You may find it necessary to cut away a portion of the inside of the grill.
6. Continue to feed the narrow end of cable # 5169-B through the round hole in the terminal buffer plate which is behind the speaker. Connect this to P2 on PCB # 5169-A.
7. Feed the grounding strap of cable # 5169B under PCB # 5169A, around the top of the keyboard assembly and attach to the chassis grounding screw (with existing systems chassis ground) at the right hand side of the terminal.
8. Reinstall the terminal top cover.
9. Connect the Male DB 25 pin connector on the end of cable # 5169-B to the back of the unit.
10. Program for Terminal Type 52.
11. For the installation of input devices, RS 232 devices and power supplies, refer to Section 2.

- **NCR 280 - BUFFERED KEYBOARD**

1. Be sure the NCR 280 terminal is powered down. Remove the top cover from the terminal.
2. Locate the smaller printed circuit board that is under the main keyboard printed circuit board. Remove the connector on the left.
3. Install cable # 5169-B between the terminal connector and the terminal keyboard (small printed circuit board). **NOTE:** It may be necessary to remove the keyboard from the terminal to connect this.
4. Feed the narrow end of cable # 5169-B through a convenient slot in the rear of the terminal top cover. You may find it necessary to cut away a portion of the inside of the grill.
5. Continue to feed the narrow end of cable #5169-B through the round hole in the terminal buffel plate which is behind the speaker. Connect this to P2 on PCB # 5169-A.
6. Feed the grounding strap of cable #5169B under PCB # 5169A, around the top of the keyboard assembly and attach to the chassis grounding screw (with existing systems chassis ground) at the right hand side of the terminal.
7. Reinstall the terminal top cover.
8. Connect the Male DB 25 pin connector on the end of the cable # 5169-B to the back of the unit.
9. Program for Terminal Type 52.
10. For the installation of input devices, RS 232 devices and power supplies, refer to Section 2.

- **NCR 2151**

1. Be sure the NCR 2151 terminal is powered down. Facing the front of the terminal, remove the lower front panel by turning the two (2) fastener screws one quarter (1/4) turn counter- clockwise and then slide the cover straight out.
2. Locate any cables that may be attached to the front of the two printed circuit boards (PCB's). Note the orientation of the cables and remove each one from the PCB's by gently pulling them straight out.
3. Unlatch the PCB slide mechanism by pushing the tab of each slide (located between the upper and lower PCB), toward the outside of the terminal and pulling the slide assembly straight out until the slides stop (about 6").
4. Unlatch the two PCB's from the slides by pushing the tab of each slide (located on either side of the lower PCB) toward the outside of the terminal and pulling both PCB's straight out until the rear of the PCB's are even with the front of the terminal (about 6").

5. Locate I/O cable P7 (located at the rear left corner of the top PCB). First note the orientation of the cable and then slide the cable off the connector.
6. Connect J7 (located on the bottom of the PCB - DCF 5151) to the P7 connector (located at the left rear of the top PCB). Carefully align the connector pins before sliding the DCF 5151 forward on to the PCB connector.
7. Connect the I/O cable P7 (removed in step 5 above), to the J7A connector (located on the top of the PCB# 5151). Orient the cable in the same direction as it was when connected to P7 of the PCB.
8. Locate the large 60 pin connector at the center/left of the top PCB. Holding the PCB/s steady, SLOWLY pull the long lever of the connector STRAIGHT out (about 1/2").
9. Place cable plug T1 (the end of the short cable attached to the PCB - # 5151), all the way to the front of the 60 pin PCB connector.
10. SLOWLY push the long lever of the connector STRAIGHT in.
11. Connect the AMP Housing end of Cable 5156/84 the J1 connector on PCB - # 5151.
12. Make sure that all cable connections are secure. SLOWLY slide the PCB/slide assembly back into the terminal until all latches are secure.
13. Feed the grounding strap of cable # 5156 to the front of the terminal and attach to the chassis grounding stud on the left front.
14. Reconnect all cables removed in step 2 above. Reinstall the front cover of the terminal, threading the cable (# 5156/84) down the front left side of the terminal and the bottom between the front cover and terminal chassis.
15. Connect the Male DB 25 pin connector on the end of the cable (# 5156/84) to the back of the reader.
16. Program for Terminal Type 36.
17. For the installation of input devices, RS 232 devices and power supplies, refer to Section 2.

- **NCR 2152**

1. Be sure the NCR 2152 terminal is powered down. Facing the front of the terminal, screw inward the two (2) large pan head screws that fasten the top half of the terminal to the bottom half.
2. Lift up the top half of the terminal from the front, (the terminal is hinged at the back). Use the two (2) support rods, located at the left and right sides of the terminals' bottom half to hold up the terminals' top half.
3. Locate the plate covering the printed circuit boards (PCBs). Loosen (DO NOT REMOVE) any screws holding down the plate. Slide the plate to the left, lift the plate up over the screw heads, and remove. This exposes the component side of the top PCB.
4. Find the keyboard interface connector at the left rear of the lower (larger) PCB. Depending on the model of the terminal, this is either connector J12 or J8. Note the connectors' orientation for future reference.
5. Remove the keyboard interface connector located above and connect it to J12A (located on PCB - # 5152).
6. Connect P12 of DCF 5152 to the mating connector (J12 or J8) on the PCB.
7. Feed the grounding strap of Cable # 5157 above the terminal power supply shield and attach it to the screw on the back left (with existing systems chassis ground).
8. At the inside left rear of the terminal base (at the back of the terminal), locate the two (2) wing nuts holding the cable strain relief bracket in place. Loosen the wing nuts enough to feed the 26 pin connector end of Cable # 5157 upward through the opening on the left side of the terminals rear panel, and through the cable strain relief.
9. Now connect the 26 pin connector of # 5157 to J1 of # DCF 5152 and secure the cable using the wing nuts and strain relief plate loosened above.
10. Replace the plate over the PCB's and return the hood support rods and hood to their original positions. Back out the two (2) screws at either side of the terminal top to secure the top to the terminal bottom.
11. Connect the Male DB 25 pin connector on the end of the Cable # 5157 to the back of the unit.
12. Program for Terminal Type 37.
13. For the installation of input devices, RS 232 devices and power supplies, refer to Section 2.

- **NCR 2154/2155**

1. Be sure the NCR 2154/2155 terminal is powered down.
  2. Remove the keyboard assembly by locating the tabs which are immediately underneath the front of the keyboard. Push the tabs inward. Lift the keyboard up and pull out.
  3. Locate the 6 pin phone plug inserted in the keyboard printed circuit board (PCB). Remove this plug and connect it to the 6 pin phone socket of the 5133 cable.
  4. Connect the 6 pin phone plug on the 5133 cable into the keyboard PCB.
  5. Route the 5133 cable past the ON/OFF switch of the terminal and up through the power switch slot in the keyboard assembly.
  6. Reinstall the keyboard assembly.
  7. Program for Terminal Type 39.
  8. For the installation of input devices, RS 232 devices and power supplies, refer to Section 2.
- **NCR 7052**
    1. Be sure the NCR 7052 terminal is powered down.
    2. Remove the back panel from the NCR 7052.
    3. Disconnect the keyboard cable and attach it to the female end of Cable # 5183. Attach the male end of Cable # 5183 to the keyboard connection inside the back of the 7052.
    4. Connect the Male DB 25 pin connector on the end of Cable # 5183 to the back of the unit.
    5. Plug the Power Supply into the connector on the back of the unit.
    6. A Power Supply is required. A standard power supply can be used if only a 5 volt input device is attached to the reader. If a 12 Volt input device is being used, the laser power supply must be also be used.
    7. Program for Terminal Type.
 

109 Keys =	60
30 Keys =	61
50 Keys =	61
    8. For the installation of input devices, RS 232 devices and power supplies, refer to Section 2.
  - **IBM 3653**
    1. Open Terminal Printer Access Door.
    2. Open Journal Access Door.
    3. To remove the right side cover from the terminal, loosen the large screws at the front and rear of the panel, then pull back and out.
    4. Remove the lamp display/keyboard cover by loosening screws at the top corners of the cover.
    5. Lift the rear of the cover and slide it back to disengage slide locks located at the lower corners of the keyboard cover.
    6. Position cover at front of terminal without straining the wires going to the lamp display.
    7. Locate the keyboard connector at the left of the keyboard. Note the orientation of this connector for future reference.
    8. Remove the connectors black "C" clip retainer and then connector from the keyboard.
    9. Connect the keyboard cable to PCB 5162-A. **NOTE:** The wire side of the keyboard connector pins go to the pins nearest the outside edge of cable # 5162-A.
    10. Install PCB # 5162-2 on to the keyboard connector and replace "C" clip retainer.
    11. Feed the small connector end of # 5162-B/5177B (Cable) through the bottom rear (right side) access hole and route the cable up to J1 of PCB # 5162-A.
    12. Attach the pig-tail grounding connector to bolt located on the left side of the terminal, in back of the speaker. The bolt indicated is the only one of four in the area without an extra ground connection on it.
    13. Using a tie wrap, strain relief the cable as it exits the unit at the back.
    14. Make certain that all cables are not causing an obstruction to any moving parts or covers.
    15. Replace the Lamp Display/Keyboard cover and the right side cover.
    16. Connect the Male DB 25 pin connector on the end of the cable # 5162/5177 to the back of the unit.
    17. Program for Terminal Type 44.
    18. For the installation of input devices, RS 232 devices and power supplies, refer to Section 2.
    19. **Power OFF & ON the Terminal after the completion of programming.**

20. If the unit has previously been connected to an IBM 4683 Terminal, it will be necessary to "Default" the programming menus that pertain to Industrial Codes.

- **IBM 3683**

1. Remove the top cover of the terminal by disengaging the locks located in the slot between the upper and lower terminal housing near the front of the terminal on the left and right sides.
2. Remove the keyboard by lifting straight up.
3. Remove the entire printer assembly
4. Move forward the black locking lever on either side located at the base of the terminal near the front.
5. Remove the ground strap from the right side of the front PCB.
6. Lift the entire printer assembly straight up and out.  
**WARNING:** Before performing the next step, note the orientation of the keyboard connector.
7. Remove the keyboard connector by flexing the lock tabs holding the connector in place.
8. Slip the plastic card guide from the top of the keyboard connector (J16) and place it on top of Cable # 5161-C (J16A).
9. Feed the keyboard connector through the terminal cover hole, (under the printer support plate toward the back of the terminal).
10. Attach J16 to P16 of cable # 5161-A. Attach cable # 5161-A to the bottom plate of the terminal with the velcro strips.
11. Feed the J2 end of cable # 5161-C through the terminal (follow the same route as Step 6). Attach J2 to P2.
12. Attach J16A to the cover by flexing the locktabs.
13. ***Make sure the orientation is the same as when J16 was removed.***
14. Remove the rear access panel (wedge) by sliding straight out.
15. Remove the fan shroud by pulling straight out.
16. Feed J1 of cable # 5161-B through the rear cover and between the fan and the card cage. Attach J1 to P1 of cable # 5161-A.
17. Use tie wraps to provide strain relief to the cable along its path to the rear exit of the terminal.
18. Attach the grounding strap from Cable # 5161B to any male quick disconnect on chassis ground plane at the rear of the terminal.
19. Replace
  - a) Fan Shroud
  - b) Rear Access Panel
  - c) Printer Assembly
  - d) Keyboard
  - e) Top Cover
20. Connect the Male DB 25 pin connector on the end of the cable the back of the unit.
21. Program for Terminal Type:

48 Key =	43
35 Key =	51
22. For the installation of input devices, RS 232 devices and power supplies, refer to Section 2.
23. **Power OFF & ON the Terminal after the completion of programming.**
24. If the unit has previously been connected to an IBM 4683 Terminal, it will be necessary to "Default" the programming menus that pertain to Industrial Codes.

- **IBM 4683**

When interfaced to the IBM 4683, the unit is not considered a wedge. The unit emulates the functions of the IBM 1520 Hand-Held Scanner Model A02 and/or IBM Dual Track Magnetic Stripe Reader attached to the 5B port of the 4683.

**Possible Wedge to IBM 4683 Interface Configurations are:**

- Wedge attached to Port 5B using Cable 5167.
- Wedge and Magnetic Stripe Reader attached to Port 5B using Cable 5167.
- Wedge and IBM Dual Track Magnetic Stripe Reader attached to Port 5B using the IBM 5B Port "Y" Cable (IBM Part Number 25F6266) and Cable 5167.
- Wedge attached to Port 17 with Cable 5119 and IBM Dual Track Magnetic Stripe Reader attached to Port 5B. This is the same configuration as above, with the exception of the "Y" cable.

**NOTE:** These configurations may be used only if another IBM device is needed that required a Port 17 attachment.

**Installation Procedures:**

1. Be sure the IBM 4683 terminal is powered down.
2. Plug into the 5B Port Cable # 5167 or plug into Port 17 Cable # 5119.
3. Program for Terminal Type 45.

**Wedge to IBM 4683 considerations:**

- The unit when connected to the IBM 4683, must be powered up, programmed for Terminal ID, and then powered off and on for proper operation. This sequence is only necessary upon installation of a unit that has not previously been programmed for the proper ID.
- Preambles and Postambles may not be used. If similar additions are necessary to the output record, CAPE should be used.
- Since this interface is not considered a wedge, the following parameters will not apply:
  - Keyboard Functions
  - Intercharacter Delays
  - Interfunction Delays
- Even though the Wedge emulates a Dual Track Magnetic Stripe Reader, it can be configured with only a single track reader (Track 1 or 2). The 4683 can process either single or dual track input as if it came from a dual track reader. The data format from the Wedge is the same as from the dual track reader.
- Buffering of data records is automatically disabled when ID 45 is selected. This prevents a possible buffer overflow at the 4683.
- All featured bar code symbologies can be read by the wedge, but symbologies other than the following along with any Auxiliary Port data (RS 232) will be identified to the 4683 as Code 3 of 9 data.

UPC-A	EAN - 8
UPC-E	EAN - 13
CODE 3 OF 9	INTERLEAVED 2 OF 5
- CAPE editing may be used on data from the magnetic card reader attached to the wedge if the Start and Stop Sentinel are not edited from the card data. The 4683 requires the Start and Stop Sentinels to format the data.
- It is recommended that any time the unit is moved from one terminal to another, that the parameters be defaulted and the unit reprogrammed.



### IBM 4680 Systems Controller Considerations

- At the systems controller, from the SYSTEM MAIN MENU, select the following from the different menus.
  - Select # 4 - Installation and Update Aids
  - Select # 1 - Change Configuration Data
  - Select # 1 - Terminal Configuration
  - Select # 1 - Terminal Device Groups
  - Select # 1 - Define a Terminal Device Groupor
  - Select # 2 - Change/Display a Terminal Device Group
- At this point, the system will ask for the name of the terminal device group being processed.
- Enter a group name. Example: ADXGRP09
- A line drawing of the back of the 4683 POS will now be displayed. The operator is prompted to type an "X" in each box that has a cable connected to it. Place an "X" in the box designated as "5B". **NOTE:** If the unit uses Cable 5119 for the Port 17 interface, place an "X" in the box designated "5B", NOT "17".
- Type the information to describe the device in Port "5B".
  - Device Type 1 = Wedge Only
  - Device Type 4 = Wedge with Magnetic Stripe Reader, including IBM Magnetic Stripe Reader
- The scanner good read "ENABLE TONE" prompt has no effect on the unit since the beeper for unit is controlled through the menus.
- Desired Label Type. Place an "X" in the box relating to the type of symbology to be read. If a symbology is to be read by the unit, but is not listed by the 4683, put an "X" in the box marked Code 39.
- The selections for Magnetic Stripe Reader must be answered if Device Type 4 was selected above.
  - Model 1 = Wedge Magnetic Stripe Reader
- Select "Track 2" regardless of the type of magnetic stripe reader attached to the wedge.
- Return to the IBM 4680 Store System "CONFIGURATION" menu. Select # 5 = Active Configuration
- From the "ACTIVE CONFIGURATION" menu. Select # 1 = Terminal Configuration
- This completes the changing and activation of the terminal configuration necessary to accommodate the wedge.
- Return to the "INSTALLATION AND UPDATE AIDS" menu. Select # 3 = Change Input Sequence Table Data
- Using the "INPUT SEQUENCE TABLE UTILITY", set up the following tables to conform to the bar code and magnetic stripe labels being used in the application.
  - Input State
  - Label Format
  - Modulo Check

### IBM 4683 - Unit Testing

- Unit testing of the wedge and dual magnetic stripe readers may be performed by using the IBM 4680 Store System Problem Determination Guide (IBM # SY27-0316-0).
- Refer to Page 4-70, TEST 4220, to test the scanner portion. Some of the off-line tests within TEST 4220 only apply to the IBM 1520 Scanner Model A02, but all on-line tests apply to the wedge.
- Refer to Page 4-25, TEST 4080, to test the dual magnetic stripe reader portion.

**NOTE:** Only the magnetic stripe reader attached to the wedge may be tested at this time.

- **DTS 500**
  1. Be sure the DTS 500 terminal is powered down. Remove the top cover.
  2. Remove the keyboard assembly by disconnecting the flat ribbon cable at the keyboard.  
\*\* **NOTE THE ORIENTATION OF THE CABLE** \*\*
  3. Facing the terminal, position the printed circuit board (PCB) 5185 with the component side up and J1A (the 90 degree connector on the PCB) toward the rear of the terminal. Connect the cable that was removed in step two (2) to J1A in the same orientation as it was connected to the keyboard.
  4. Feed the micro-clip and red wire around to the right side of the card cage.
  5. Attach the micro-clip to the right most lead of the capacitor C114 (lead marked plus (+) on the terminal interface board. (PCB with DB 25 connector on the right hand edge).
  6. Feed the Amp connector end of Cable 5156 up through the terminal's right side cable access and route cable through the terminal. Install on J2 of PCB 5185.
  7. Feed the flat ribbon connector T1 of PCB 5185 into position and attach keyboard.
  8. Insure that PCB 5185 is positioned so that it does not come into contact with any other circuit boards with the terminal.
  9. Reinstall keyboard and covers.
  10. Connect the Male DB 25 pin connector on the end of cable 5156 to the back of the unit.
  11. Program for Terminal Type 62.
  12. For the installation of input devices, RS 232 devices and power supplies, refer to Section 2.
  
- **TEC M-2300-41**
  1. Be sure the TEC M-2300-41 terminal is powered down.
  2. Remove the top cover from the terminal.
  3. Remove the keyboard assembly by disconnecting the 40 pin ribbon cable on the keyboard and the power cable from the register switch.
  4. Feed cable 5156 (26 pin vertical connector) into the rear of the terminal and between the 3rd and 4th printed circuit boards (PCB) from the bottom to the front of the terminal.
  5. Connect the cable from the main PCB that was disconnected from the keyboard to the supplied PCB at the connector called "B". Connect cable 5156 to the supplied PCB 26 pin vertical connector.
  6. Lay the supplied PCB flat on the main PCB in the terminal so that the bottom of the PCB lays on the 40 pin ribbon cable.
  7. Reinstall the keyboard assembly by connecting the free 40 pin ribbon cable (6 1/2" supplied with the PCB) to the keyboard assembly and reconnecting the power cable to the register switch.
  8. Make sure all cable connections are secure and reinstall the cover.
  9. Connect the Male DB 25 pin connector on the end of cable 5156 to the back of the unit.
  10. Program for Terminal Type 39.
  11. For the installation of input devices, RS 232 devices and power supplies, refer to Section 2.

#### IV. INSTALLING THE READER - DUAL PORT RS 232

Installation of the reader should be completed by a person familiar with installing and connecting computer systems and cabling.

##### 1. INSTALLATION

- a) TURN OFF POWER TO THE TERMINAL TO WHICH THE READER WILL BE CONNECTED.
- b) Plug the cable housing into the back end of the unit. Once plugged in, the cable housing should be flush with the unit.
- c) Unplug the host interface line from the terminal. Connect this line into the leg of the "Y" cable that mates with it. (Dual Port)
- d) Plug the remaining leg of the "Y" cable into the terminal where the host cable was connected. Arrange the fully connected unit so that all cables run fully and smoothly.

##### 2. CONNECTING THE SCANNING DEVICE

Plug the scanning device into the 9 pin "D" connector on the FRONT panel.

##### 3. CONNECTING THE POWER SUPPLY & TERMINAL POWER UP SEQUENCE

Plug the external power supply into the receptacle located on the back of the unit. Then plug the power supply into a power source.

After approximately 5 seconds the unit will beep twice. This delay is intentional and occurs so that the terminal - keyboard power on reset routines have time to complete.

Turn ON the power to the terminal.

##### 4. PROGRAMMING FOR SERIAL COMMUNICATIONS

**IMPORTANT:** If this is a first time installation, it is NECESSARY to program the unit for use with the connected terminal.

###### ■ SERIAL III MENU PAGE

Program Dual Port ON

###### ■ SERIAL II MENU PAGE

Program the following parameters to match the setting for Terminal to Host Communications.

Stop Bits  
Baud Rate  
Parity  
Word Length

## ■ OPTIONAL SELECTIONS

Program the following parameters to match the setting for Terminal to Host Communications.

Serial I  
Intercharacter Delay  
Interfunction Delay  
Serial III  
Buffer Mode  
Protocol  
Transmit Data  
Fixed Length Message

## 5. PROGRAMMING FOR ADDITIONAL PARAMETERS

Use the remaining programming sheets, i.e. GENERAL I, GENERAL II, SERIAL I, SERIAL II, SERIAL III, SCANNER PORT, INDUSTRIAL CODES, RETAIL CODES, KEYBOARD REMAPPING and EDIT to complete the programming.

If RS 232 data is transmitted through the Aux Port, use the following menu pages and parameters

Serial I  
Preamble  
Postamble  
Record Terminator  
Function Code  
Serial III  
Aux Port Protocol

**DEFAULT:** Each sheet has default parameters associated with it which are indicated by asterisks "\*" on the programming menus.

*To assign these DEFAULT parameters,*

4. scan the ENTER symbol
5. scan the DEFAULT symbol
6. scan the EXIT symbol

*If Default parameters are not desired,*

5. scan the ENTER symbol
6. scan the desired parameter
7. scan the letter/digit combination listed on the programming sheet
8. scan EXIT

*After the EXIT symbol is scanned, the program information is stored in non-volatile memory and will not have to be programmed again unless changes are desired.*

**INSTALLATION IS NOW COMPLETE**

#### IV. PROGRAMMING THE UNIT

The unit is pre-programmed with standard default parameters that allow you to use it without programming. For customization, you can change any of the parameters by scanning the bar code labels in the programming menus. Once the parameter is selected, it is stored in non-volatile memory, and will not change unless the unit is reprogrammed.

**IMPORTANT:** If this is a first time installation, it is NECESSARY to program the unit for use with the connected terminal.

**DEFAULT ALL** - Reference Program Mode Menu. To default the unit, the "Default All Parameters" bar code must be read. This will issue a High-Low beep. Approximately 1 second after this two (2) High beeps will be issued signaling that the unit is now reset to factory defaults. Once Defaulted, the Terminal ID will be set to "01" and all parameters on all of the programming menus, including the edit menu, will reset to their factory setting.

The Bar Code Menus provided with each unit consist of the following pages:

- A. Terminal Selection Menu
- B. General I Menu
- C. General II Menu
- D. Scanner Port Menu
- E. Serial I Menu
- F. Serial II Menu
- G. Serial III Menu
- H. Codes - Industrial Menu
- I. Codes - Retail Menu
- J. Keyboard Remap
- K. Edit Menu
- L. Status Check Menu
- M. Parameter Selection Menu Bar Code

The following beep sequences should be noted when programming the unit.

- 1 HIGH, 1 LOW** = Good Programming Read
- 2 HIGH** = Exit Programming - Good Read
- 1 HIGH, 2 LOW** = Programming Error - Out of Sequence Programming Label
- 4 High** = Keyboard Input Required

- Example 1:** Select Terminal Type (DEC VT 320 = Terminal Type 15)
- 1. Using the TERMINAL TYPE programming menu, scan the ENTER bar code symbol.
  - 2. Using the Bar Code Chart, scan a 1, then a 5 under the digits column.
  - 3. Scan the EXIT bar code symbol.

- Example 2:** Select a Scanner Postamble  
"ABC" followed by the TAB key.  
(Codes 41,42,43,09)
- 1. Using the SCANNER PORT programming menu, scan the ENTER bar code symbol.
  - 2. Scan the Postamble bar code
  - 3. Using the Bar Code Chart, scan a 4,1,4,2,4,3,0,9 using both the alpha and digits columns.
  - 4. Scan the EXIT bar code symbol.

***DEFAULT SELECTIONS***

1) ***ALL SELECTIONS***

To default back to the factory set parameters scan the DEFAULT ALL symbol on the Status Programming Menu. After the bar code is scanned, a high-low beep sequence will be emitted from the unit

**Note:** DEFAULT ALL will delete all edits and remapping sequences that have been programmed.

2) ***PER MENU PAGE***

To default to the factory set parameters by menu page, scan:  
Enter - for the page parameters you wish to default  
Default  
Exit

**CLONING**

Reference Program Mode Menu. Cloning is a programming method that copies the setup from one unit to another. Once you have programmed and tested one unit and verified that the data input and output is correct, you can use that unit as the “master” to program the other unit in with the identical program.

Cloning is achieved by transmitting the program from the master to the attached unit via cable # 0223811 from Port 2 of the master to Port 2 of the unit to be cloned.

***CLONING A UNIT***

- 1: Power up both the master and receiving unit. Power can be supplied from a keyboard interface or from an external power supply.
- 2: Connect the master and receiving unit. Plug Cable # 0223811 into the Aux Port of both units.

**Cable # 0223811 - Pin Outs**

<b>MASTER Unit</b>		<b>RECEIVING Unit</b>	
RTS	1 -----	4	CTS
TRANSMIT	2 ----->	8	RECEIVE
CTS	4 -----	1	RTS
GROUND	6 -----	6	GROUND
RECEIVE	8 <-----	2	TRANSMIT

- 3. **RECEIVING** Unit - Scan the **CLONE IN** label (Program Mode Menu)
- 4. **MASTER** Unit - Scan the **CLONE OUT** label (Program Mode Menu)
- 5. The Master Unit will transmit to the Receiving Unit the same parameters that it was programmed for.
- 6. Disconnect the Aux Port Cable from the Receiving Unit.
- 7. Recycle power on the Receiving Unit to initialize the transmitted parameters.

## V. GENERAL PROGRAM SELECTIONS

### 1. TERMINAL SELECTIONS

#### a) *INTERFACE SELECTION - KEYBOARD WEDGE*

Menu Page = **Terminal Selection**

This parameter programs the unit for the terminal it is attached via the keyboard.

Sequence of operation for programming the terminal selection

- a) Scan "ENTER TERMINAL SELECTION"
- b) Scan the two (2) digit number corresponding to the terminal desired.
- c) Example: For an IBM 3180-1 Terminal, Scan a "0" then a "5" on the Bar Code Menu Page.
- d) Scan "EXIT TERMINAL SELECTION"

#### b) *INTERFACE SELECTION - SERIAL OUTPUT*

Menu Page = **Terminal Selection**

This parameter programs the unit for RS 232 serial communications.

- External Power Supply Required
- Set Communication Parameters using the Serial I, II and III Menu Pages.
- **Single Port RS 232 - Data Output**
  - a) Scan "ENTER TERMINAL SELECTION"
  - b) Single Port RS 232 ID = 31
  - c) Scan "3" then a "1" on the Bar Code Menu Page.
  - d) Scan "EXIT TERMINAL SELECTION"

### 2. GENERAL I MENU

Menu Page = **General I**

This menu page is used to program various functions that apply to all input through the unit.

The DEFAULT Selections for the General Menu are indicated on the menu by an asterisk "\*"

<b>BEEPER VOLUME =</b>	7
<b>INPUT INHIBIT CHECK =</b>	OFF
<b>KEYBOARD TYPE =</b>	PRIMARY
<b>INTERCHARACTER DELAY =</b>	00 (NONE)
<b>INTERFUNCTION DELAY =</b>	00 (NONE)

- **Beeper Volume**

The unit will emit a beep after each successful read. This beep can range in volume from 0 (OFF) to 7 (HIGH). The default is 7 (HIGH).

- **Input Inhibit Check**

In most terminal environments, the terminal is often “inhibited” from sending data to the host CPU. This happens after a screen or page of data is sent to the host CPU by the operator activating the “XMIT”, “REC ADV”, or “ENTER” key. Further input from the keyboard is ignored by the terminal as long as input is inhibited by the host.

Reference Appendix A for terminals that allow monitoring of the Input Inhibit line.

Reference Appendix G for terminals that require the installation of leads inside the terminal to monitor input inhibit.

Reference Appendix F for further usage of Input Inhibit during data transmission

- **Keyboard Type**

Most terminals supported by the unit can have one of two styles of keyboards attached to it. Through programming you can change from one type to another.

The types of keyboards are often referred to as:

- ◆ Typewriter versus Data Entry
- ◆ 122 Keys versus 102 Keys
- ◆ No Caps Lock versus Caps Lock
- ◆ Telephone versus Calculator

**NOTE:** Caps Lock on Versus Caps Lock Off

Output of alpha data to the terminal is affected by the ON or OFF state of the CAPS LOCK key. Under default, the unit assumes that CAPS LOCK is OFF and sends the "SHIFT" key prior to the output of alpha data. The alpha data then appears as upper case characters.

However, if the terminal program functions with CAPS LOCK ON, the addition of the "SHIFT" key sends the data to the terminal as lower case alpha characters. If this is the case, the Keyboard Type should be set to Secondary.

- **Intercharacter Delay**

This parameter is used to establish an intercharacter delay time of 10 to 990 milliseconds. The delay will appear after each character is transferred to the terminal screen.

This delay parameter should be specified if you find that the terminal cannot keep up with the speed at which the unit is sending data to the screen, or if the host program is inserting multiple keyboard functions into the data being entered.

- **Interfunction Delay**

This parameter is used to establish an interfunction delay time of 10 to 990 milliseconds. The delay will appear after each keyboard function is transferred to the terminal screen.

This delay parameter should be specified if you find that the terminal cannot keep up with the speed at which the unit is sending data to the screen, or if the host program is inserting multiple keyboard functions into the data being entered.



### 3. GENERAL II MENU

#### Menu Page = **General II**

The second General Menu is also used to program various functions that apply to input through the unit.

The DEFAULT Selections for the General Menu are indicated on the menu by an asterisk "\*"

<b>MAGNETIC TRACK</b>	= TRACK 2
<b>BUFFERING</b>	= ON
<b>SCALE SOLICIT RECORD</b>	= NONE
<b>SWITCHES</b>	
1) Output Edited Records Only	= OFF
2) IBM 3683 Keyboard Variation	= OFF
3) IBM 3683 Keyboard Variation	= OFF
4) ----	= OFF
5) ----	= OFF
6) IBM PC/AT – w/o Keyboard	= OFF
7) ----	= OFF
8) Laser with AutoSense	= OFF

- **Magnetic Track / Auxiliary Port**

This parameter is used to establish the use of the Auxiliary Port. The choices are either RS 232 Input from portables or scales, or input from a magnetic stripe reader.

If a magnetic stripe reader is attached, the unit must be programmed to match the output of the reader.

The options are:

- RS 232 Input
- Track 1
- Track 2
- Tracks 1 & 2 – 1 Only
- Tracks 1 & 2 - 2 Only
- Tracks 1 & 2 – Both Tracks
- Tracks 1 & 2 – Any Valid Track

- **Buffering**

This parameter is used to set the buffering mode of the unit. This parameter only applies to the data being received from one of the scanner ports.

If the buffer is ON (Default), and the attached terminal is not ready to accept data, the unit will buffer up to 32 entries, maximum of 64 characters per entry.

If the buffer is OFF, the unit will not accept another entry until the record previously read has been transmitted to the attached terminal and the buffer has been cleared.

- **Scale Solicit Record**

Typical usage for this parameter is when for an application requires a scale to be attached to the RS 232 auxiliary port. Most scales require that a record be sent to it prior to initiating the response from the scale.

This parameter is used to set the ASCII character or characters that will be transmitted. The defined character(s) will be held in the units buffer under the Hex 05 Function Code - Referred to as SOLA (Solicit). Whenever the Hex 05 Function Code is programmed into the output record (preamble, postamble, output edit) the solicit record in the buffer will be sent out to the attached scale. Once received, the scale will respond by transmitting the data string containing the weight information back to the wedge.

A maximum of four (4) ASCII characters can be programmed.  
The default value for this parameter is "NONE".

**Example:**

The scale requires a "P" followed by a "Carriage Return" sent to it prior to it transmitting the weight data out the RS 232 Port.

Program the unit for a Scale Solicit Record of 50, 0D. Whenever the SOLA Function Code (Hex 05) (Postamble or Singular Function Code) is inserted in the data string, the record (Hex 500D) will be transmitted out the RS 232 port to the scale, causing the scale to respond with the transmission of the weight data back to the wedge.

- **Selector Switch 1: Output Edited Records Only**

This parameter is used to establish what input records will be transmitted to the terminal.

If this parameter is ON, only the records that have been defined and edited via the EDIT Program Parameters will be passed through to the terminal.

If this parameter is OFF (Default), all input will be passed through to the terminal. This includes both edited and non-edited records.

- **Selector Switch 2 & 3: IBM 3683 "0" vs "00" Key Position**

The On/Off state of Switches 2 & 3 determine the key position of the "0" versus the "00" key on the IBM 3683 keyboard. Reference Appendix D: IBM 3683 for keyboard layout and program instructions.

- **Selector Switch 4 - 5: NOT ACTIVE**

- **Selector Switch 6: IBM PC/AT without keyboard**

If the unit is attached to an IBM PC/AT without a keyboard, this parameter should be set to ON.

During the power up sequence, the terminal checks for the presence of a keyboard. If the keyboard is not present, the unit will send back the required "keyboard present" signal to the terminal.

If OFF, a keyboard must be attached to avoid the error condition that is emitted by the terminal when it checks for the presence of a keyboard during the start-up sequence.

- **Selector Switch 7: NOT ACTIVE**

- **Selector Switch 8: Laser with Auto Sense**

If the Auto Sense option is installed on the attached laser input device, Switch 8 should be turned on.

## VII. SCANNER PORT MENU

### Menu Page = **Scanner Port**

This menu page is used to program various functions that apply to input through the Scanner Port.

The DEFAULT Selections for the Scanner Port Menu are indicated on the menu by an asterisk "\*"

**PREAMBLE** = NONE  
**POSTAMBLE** = NONE  
**LASER REDUNDANCY** = OFF  
**FUNCTION CODES** = OFF  
**CODE IDENTIFICATION** = OFF

- **Preamble & Postamble**

The user may specify a Preamble and/or Postamble (maximum of 16 characters each) to precede or follow each code scanned.

Preamble	Scanned Data	Postamble
----------	--------------	-----------

**NOTE:** Embedding the "ENTER", "REC ADV", or "XMIT" keys within the data being transmitted will result in either a portion of, or all of the data following these key functions not be transmitted to the screen.

To prevent loss of data, only use the "ENTER", "REC ADV", or "XMIT" keys as the last character of the Postamble or program in an adequate "Pause" after the function to allow for a new screen to appear.

When programming for a Preamble and/or a Postamble, the Hex representation for each character desired must be entered. Refer to either the Key Code Chart in Appendix C.

**NOTE:** Any programmed Preamble & Postamble will not be included in the output for a record that has been edited. If a Preamble or Postamble is required on an edited record, it must be included in the edit.

- **Laser Redundancy**

When enabled, the unit will require two (2) identical reads of a bar code to be decoded prior to accepting the bar code input and signaling for the light source to be turned off on the input device.

- **Function Codes**

If Keyboard Function Codes (i.e., Field Forward, Xmit, etc.) are embedded within the bar codes that are being read, this feature must be turned ON. See Appendix B for a listing of the keyboard functions and the programmed codes associated with each function.

- **Code Identification**

This parameter programs the unit to precede the transmission of each bar code read with a character that identifies the type of symbology the code was printed in. The symbologies and their identifiers are as follows:

CODABAR	= a	CODE 3 OF 9	= b	UPC-A	= c
EAN	= d	I 2 OF 5	= e	2 OF 5	= f
CODE 128	= j	CODE 11	= h	CODE 93	= I
PLESSEY	= g	CODABLOCK	= k		

## VIII. SERIAL INPUT/OUTPUT SELECTIONS

### Menu Pages - Serial I, Serial II and Serial III

The Serial I, II and III menu pages are used to program various functions that pertain to either serial input or output through the RS 232 Auxiliary Port or Dual/Single Port RS 232 Output.

#### 1. SERIAL I SELECTIONS

The DEFAULT Selections for the Serial I Menu are: (indicated by an asterisk on the menu)

<b>PREAMBLE</b>	= NONE
<b>POSTAMBLE</b>	= NONE
<b>RECORD TERMINATOR</b>	= "0D"
<b>INTERCHARACTER DELAY</b>	= 00
<b>INTERFUNCTION DELAY</b>	= 00
<b>FUNCTION CODES</b>	= OFF

- **Preamble & Postamble (AUX Port Input Only)**

Through programming, the user may specify a Preamble and/or Postamble (maximum of 16 characters each) to precede or follow all data being transmitted that was received from the RS 232 auxiliary port or Dual Serial Input.

Preamble	RS 232 Input Data	Postamble
----------	----------------------	-----------

**NOTE:** Embedding the "ENTER", "REC ADV", or "XMIT" keys within the data being transmitted will result in either a portion of, or all of the data following the these key functions not be transmitted to the screen.

To prevent loss of data, only use the "ENTER", "REC ADV", or "XMIT" keys as the last character of the Postamble or program in an adequate "Pause" after the function to allow for a new screen to appear.

When programming for a Preamble and/or a Postamble, the Hex representation for each character desired must be entered. Refer to either the Key Code Chart in Appendix C.

**NOTE:** Any programmed Preamble & Postamble will not be included in the output for a record that has been edited. If a Preamble or Postamble is required on an edited record, it must be included in the edit.

- **Record Terminator (AUX Port Input Only)**

Each data record that the unit receives from the Auxiliary Port is held in a buffer until a Record Terminator is received. Once received, the unit will discard the Record Terminator, process the data received and then transmit the data.

One character must be programmed as the Record Terminator. Any of the ASCII characters may be used as a Record Terminator. *The Record Terminator will NOT appear on the screen.* The only function of the Record Terminator is for usage by the unit to signal the end of a data record.

When programming for a Record Terminator, the Hex representation for each character desired must be entered. Refer to the Key Code Chart in Appendix C.

If the last character of the data does not match the Record Terminator specified, no data will be sent to the screen.

- **Intercharacter Delay (RS 232 Dual & Aux Port Output)**  
This parameter is used to establish an intercharacter delay time of 10 to 990 milliseconds. The delay will appear after each character is transferred to the terminal screen.  
  
This delay parameter should be specified if you find that the terminal cannot keep up with the speed at which the unit is sending data to the screen, or if the host program is inserting multiple keyboard functions into the data being entered.
- **Interfunction Delay (RS 232 Dual & Aux Port Output)**  
This parameter is used to establish an interfunction delay time of 10 to 990 milliseconds. The delay will appear after each keyboard function is transferred to the terminal screen.  
  
This delay parameter should be specified if you find that the terminal cannot keep up with the speed at which the unit is sending data to the screen, or if the host program is inserting multiple keyboard functions into the data being entered.
- **Function Codes (AUX Port Input Only)**  
If Keyboard Function Codes (i.e., TAB, ENTER, etc.) are embedded within the data being received from the RS 232 Port and are to be transmitted as keyboard functions, this feature must be turned ON.  
  
If OFF, keyboard function characters received by the unit will be ignored.

## 2. SERIAL II SELECTIONS

This menu is used to program various functions that pertain to either serial input from the Auxiliary Port or Dual Serial Output.

The DEFAULT Selections for the Serial II Menu are indicated by an asterisk on the menu.

<b>BAUD RATE</b>	= 9600
<b>PARITY</b>	= EVEN
<b>WORD LENGTH</b>	= 7 BITS
<b>STOP BITS</b>	= 1 STOP BIT
<b>AUX PORT PROTOCOL</b>	= RECORD

- **Baud Rate (RS 232 Input or Output)**

Program the Baud Rate for serial transmission compatibility with the external device connected to the Aux Port or to the host system if data output is RS 232 Single or Dual Port. If the Baud Rate compatibility is not achieved, a series of beeps will be emitted.

Selections include:

300 = A	4800 = E	600 = B	9600 = F
1200 = C	19200 = G	2400 = D	

- **Parity (RS 232 Input or Output)**

Program Parity Checking for serial transmission compatibility with the external device connected to the Aux Port or to the host system if data output is RS 232 Single or Dual Port. If Parity compatibility is not achieved, a series of beeps will be emitted.

Selections include:

MARK = A	SPACE = B	
EVEN = C	ODD = D	NONE = E

- **Word Length (RS 232 Input or Output)**

Program Word Length for serial transmission compatibility with the external device connected to the Aux Port or to the host system if data output is RS 232 Single or Dual Port. If Word Length compatibility is not achieved, a series of beeps will be emitted. Word Length can be set to either 7 or 8 bits.

- **Stop Bits (RS 232 Input or Output)**

Program Stop Bits for serial transmission compatibility with the external device connected to the Aux Port or to the host system if data output is RS 232 Single or Dual Port. If Stop Bit compatibility is not achieved, a series of beeps will be emitted. Stop Bits can be set to either one or two.

- **RS 232 Input Protocol (RS 232 Input)**

If multiple data records are being sent through the unit to the screen from an external portable reader/computer, a Data Transfer Protocol must be set. If a Data Transfer Protocol is not set, the unit will only receive data on a record-to-record basis.

A detailed explanation of each Protocol can be found in Appendix F.

Through programming you can change the Protocol to one of the following:

RECORD	= A	SOLICIT / XON	= B
BURST	= C	ACK/NAK	= D
Xmodem CRC	= E		

### 3. SERIAL III SELECTIONS

This menu is used to program various functions that pertain to Dual Serial Output.

The DEFAULT Selections for the Serial III Menu are indicated by an asterisk on the menu.

<b>DUAL PORT</b>	= OFF
<b>BUFFER MODE</b>	= RECORD
<b>PROTOCOL</b>	= READY
<b>TRANSMIT DATA</b>	= HOST
<b>FIXED LENGTH MESSAGE</b>	= OFF

- **Dual Port (RS 232 Dual Port Output Only)**

When the unit is interfaced in-line between the host and the terminal on the RS 232 communications cable, this parameter must be set to ON. This sets the unit for RS 232 output versus keyboard output.

NOTE: This parameter must be OFF if the unit is interfaced through the keyboard line.

- **Buffer Mode (RS232 Dual Port Output Only)**

This menu selection configures the unit for either a straight pass-through of data or to buffer data until a command is issued to transmit it. The menu choices for Buffer Mode include:

**RECORD** – When enabled, each bar code scanned or each record received from the Aux Port is treated as an individual record and transmitted as such.

**BLOCK** – When enabled, each scanned entry is stored in a message buffer as a ‘block’ or data, and is not transmitted until the “SEND BLOCK DATA” bar code is scanned.

**BLOCK CHECKING** – When enabled, a Block Check Character (BBC) is included in each data transmission to and from the terminal. The BBC is the “Exclusive Or” of all characters in the message, excluding the Preamble and Postamble.

- **Protocol (RS232 Dual Port Output Only)**

This menu selection is used to configure the flow control for data communication between the unit and its host. The menu choices for Protocol include:

**READY** - When enabled, data input to the unit will be immediately transmitted.

**ACK/NAK** – ACK/NAK protocol allows both the Host and the Terminal to perform ACK/NAK format parity checks on all incoming messages.

**Framed** – When enabled, each ACK and NAK will be ‘framed’ by the terminal Preamble and Postamble which has been programmed by the user.

**XON / XOFF** - When enabled, the command "DC1" from the host to the terminal will initiate communication; the command "DC3" will stop data transmissions.

**RTS / CTS** - When enabled, the RTS / CTS signal lines will control the transmission of data between the host and the terminal.

- **Transmit Data** **(RS 232 Dual Port Output Only)**  
This menu selection is used to direct the flow of data from the unit. If Host is on, the data will flow directly to the host, which in most cases echoes the data back to the display.

The data can also be sent directly to the display, or to both the display and host simultaneously.

- **Fixed Length Message** **(RS 232 Dual Port Output Only)**  
This menu selection is used when the host system cannot except variable length messages and requires all data received to be of a fixed length. The menu choices for Fixed Length Message include:

**ENABLE** – Set for ON or OFF

**LENGTH** – If ON, specify a message length between 0001 and 1024.

**FILL CHARACTER** – If ON, indicate which character should be used to fill in for messages that don't meet the specified length. Specify one HEX character only. The normal default setting is for Hex 20 (space).

**FIELD SEPARATOR** – If ON, indicate which character should be used to separate each individual record scanned into the block buffer. Specify one HEX character only. The normal default setting is for Hex 1C (FS).



## IX. BAR CODE SELECTIONS

### Menu Pages - Code Selection Industrial & Retail

These menu pages are used to enable or disable the various bar code symbologies that the unit is able to decode. They are also used to set the different variables within each code symbology.

Upon DEFAULT, the unit is able to auto-discriminate between all codes. The DEFAULT variables for each code are indicated by an asterisk on the menu.

To change any of the variables, you must:

- 1) Enter Industrial/Retail Code Selections
- 2) Scan the symbology you wish to change
- 3) Scan the Alpha for the variable you wish to change
- 4) Scan the selection within the variable.
- 5) Either select another variable, select another symbology or Exit Code Selections.

- **Codabar**

<u>Variables</u>	<u>Selections</u>	<u>Default</u>
ENABLE	ON or OFF	ON
MINIMUM LENGTH	00 -> 64	00
MAXIMUM LENGTH	00 -> 64	64
START/STOP XMIT	ON or OFF	OFF
CONCATENATE	ON or OFF	OFF

- **Code 3 of 9**

<u>Variables</u>	<u>Selections</u>	<u>Default</u>
ENABLE	ON or OFF	ON
MINIMUM LENGTH	00 -> 64	00
MAXIMUM LENGTH	00 -> 64	64
START/STOP XMIT	ON or OFF	OFF
FULL ASCII	ON or OFF	ON
CHECK DIGIT	ON or OFF	OFF
CHECK DIGIT XMIT	ON or OFF	OFF
APPEND	ON or OFF	OFF

- **Interleaved 2 of 5**

<u>Variables</u>	<u>Selections</u>	<u>Default</u>
ENABLE	ON or OFF	ON
MINIMUM LENGTH	04 -> 64	04
MAXIMUM LENGTH	04 -> 64	64
6 and 14 ONLY	ON or OFF	OFF
CHECK DIGIT	ON or OFF	OFF
CHECK DIGIT XMIT	ON or OFF	OFF

**NOTE:** Interleaved 2 of 5 symbology requires that the code read be an even number of digits.

- **Industrial 2 of 5**

<u>Variables</u>	<u>Selections</u>	<u>Default</u>
ENABLE	ON or OFF	ON
MINIMUM LENGTH	00 -> 64	00
MAXIMUM LENGTH	00 -> 64	64

- **Code 11**

<u>Variables</u>	<u>Selections</u>	<u>Default</u>
ENABLE	ON or OFF	ON
MINIMUM LENGTH	00 -> 64	04
MAXIMUM LENGTH	00 -> 64	64
ONE CHECK DIGIT	ON	
TWO CHECK DIGITS	ON	ON

- **Code 93**

<u>Variables</u>	<u>Selections</u>	<u>Default</u>
ENABLE	ON or OFF	ON
MINIMUM LENGTH	00 -> 64	00
MAXIMUM LENGTH	00 -> 64	64

- **Code 128**

<u>Variables</u>	<u>Selections</u>	<u>Default</u>
ENABLE	ON or OFF	ON
MINIMUM LENGTH	00 -> 64	00
MAXIMUM LENGTH	00 -> 64	64

- **Plessey**

<u>Variables</u>	<u>Selections</u>	<u>Default</u>
ENABLE	ON or OFF	OFF
MINIMUM LENGTH	04 -> 64	04
MAXIMUM LENGTH	04 -> 64	64

- **Codablock**

<u>Variables</u>	<u>Selections</u>	<u>Default</u>
ENABLE	ON or OFF	ON
*MINIMUM LENGTH	01 -> 64	01
*MAXIMUM LENGTH	01 -> 64	64
START/STOP XMIT	ON or OFF	OFF
FULL ASCII	ON or OFF	ON
CHECK DIGIT	ON or OFF	OFF
CHECK DIGIT XMIT	ON or OFF	OFF

\* Minimum and Maximum Lengths specified are for each line within the Codablock label. The total Codablock length is not programmable. The absolute maximum for a total Codablock label is 1364 characters.

- **UPC**

<u>Variables</u>	<u>Selections</u>	<u>Default</u>
UPC A	ON or OFF	ON
UPC E	ON or OFF	ON
2 DIGIT SUPPLEMENT	ON or OFF	ON
5 DIGIT SUPPLEMENT	ON or OFF	ON
CHECK DIGIT XMIT	ON or OFF	ON
NUMBER SYS XMIT	ON or OFF	ON
ZERO SUPPRESS	ON or OFF	ON

- **EAN**

<b><u>Variables</u></b>	<b><u>Selections</u></b>	<b><u>Default</u></b>
EAN.JAN 8	ON or OFF	ON
EAN/JAN 13	ON or OFF	ON
2 DIGIT SUPPLEMENT	ON or OFF	ON
5 DIGIT SUPPLEMENT	ON or OFF	ON
CHECK DIGIT XMIT	ON or OFF	ON

## X. EDIT PROGRAMMING

### CUSTOMER APPLICATIONS PROGRAMMABLE EDIT (CAPE)

It is **strongly advised** that **Section 9** be read in its entirety and that a **Worksheet** be filled out **BEFORE** you attempt to program any of the CAPE features.

The Customer Applications Programmable Edit, referred to as CAPE, is a means by which the user can qualify the raw data record passing through the unit and then define the output format of the data record.

The menu programmable features allow the user the following flexibility.

- **DATA QUALIFICATION:**

1) Specify which port the data record can be received from.

Scanner  
Auxiliary RS 232  
Magnetic Stripe

2) Specify which symbology the data record must be represented by.

Code 3 of 9	Code 11
Codabar	Code 93
I 2 of 5	Plessey
2 of 5	UPC
Code 128	EAN
All = Any symbology, RS 232 or Mag Stripe	

3) Specify the length of the data record.

Actual length  
Variable Length

4) Specify by position in the data record a match to a specific ASCII character.

Example:  
Position 3 of the record must be a "T" and  
position 5 of the record must be a "7".

*Qualification Example:*

A 6 digit Code 3 of 9 bar code with a "5" as the second digit.

Qualify =       Scanner Port  
                  Code 3 of 9  
                  Six digits  
                  "5" = second position

Only a record passing all four qualifications will pass the edit.

- **OUTPUT FORMAT OPTIONS**

- 1) **Add** data and/or Function Codes to the record
  - Preambles
  - Postambles
  - Insert Within Output Record
- 2) **Delete** data from the record.
  - Examples:
    - Do not output field identifiers
    - For Mag Stripe input, only output the Account Number and Expiration Date.
- 3) **Rearrange** data from the input record to match the output format.
- 4) **Repeat** data found in the input record. Output the same data more than once.
- 5) **Define two output formats** for one input record.
  - The second of the two output formats is activated by reading a "Switch Label".

***Output Format Example:***

- 1) Delete and Add

Input = 123T456  
Output = 123<TAB>456<ENTER>

- 2) Add, Delete and Rearrange

Input = ;5928394920033=92059032490834?  
Output= 9999<TAB>5928394920033<ENTER>0592<ENTER>

**EDIT WORKSHEET**

DATA INPUT: \_\_\_\_\_

DATA OUTPUT: \_\_\_\_\_

**EDIT NUMBER:** \_\_\_\_\_ OF \_\_\_\_\_

Secondary Switch: \_\_\_\_\_

Deactivate Switch: \_\_\_\_\_

Secondary Output Record: \_\_\_\_\_

PORT = \_\_\_\_\_ **CODE** \_\_\_\_\_

SYMBOLGY = \_\_\_\_\_ **CODE** \_\_\_\_\_

**INPUT RECORD LENGTH** \_\_\_\_\_

**NUMBER OF INPUT FIELDS** \_\_\_\_\_

#	LENGTH	FUNCTION CODE	MATCH

**NUMBER OF ADDITIONAL FIELDS:** \_\_\_\_\_

#	LENGTH	DATA (Minimum of 15)

**OUTPUT SEQUENCE:** \_\_\_\_\_

**PROGRAMMING EXAMPLE # 1**

Use of **Match** Code & **Added** Function Codes

INPUT RECORD: N1234567

OUTPUT RECORD: 1234<Field Forward>567<Enter>

ENTER EDIT PROGRAMMING

Edit Number **01**  
Port **1** (Scanner)  
Symbology **B** (3 of 9)  
Input Length **08**  
# of Fields **03**  
Field 1  
Length **01** (N)  
Function. Code **4E** (N = Hex 4E)  
Match Code **0N** (Field = N)  
Field 2  
Input Field Length **04** (1234)  
Function Code **0B** (Tab)  
Field 3  
Input Field Length **03** (567)  
Function Code **0D** (Enter)  
Added Fields **00**  
Added Field Length Ignore  
Added Field Data Ignore  
Output Sequence **02, 03**

EXIT EDIT PROGRAMMING

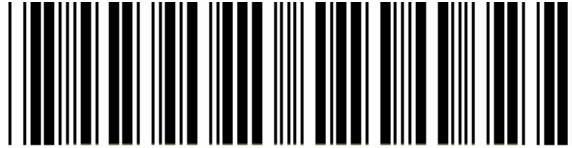

N 1 2 3 4 5 6 7

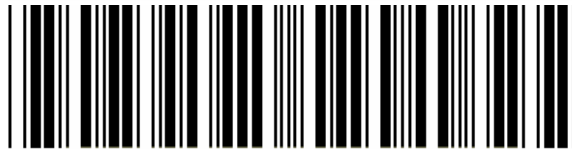

V 1 2 3 4 5 6 7

- NO CHANGE IN OUTPUT
- MUST BEGIN WITH "N" FOR VALID EDIT

**PROGRAMMING EXAMPLE # 2**

**Added Data & Rearrange Fields**

INPUT RECORD: 1234567890  
OUTPUT RECORD: 67890-BAR<ENTER>12345-CODE<ENTER>

ENTER EDIT PROGRAMMING

Edit Number 01  
Port: 1 (Scanner)  
Symbology B (CODE 3 OF 9)  
Input Record Length 10  
Fields In Input Record 02  
Field 1  
Input Field Length 05 (12345)  
Function Code 00 (Null)  
Field 2  
Input Field Length 05 (67890)  
Function Code 00 (Null)  
Added Fields 02  
Field 3  
Added Field Length 05  
Added Field Data 2D, 42, 41, 52, 0D  
( - B A R )  
Field 4:  
Added Field Length 06  
Added Field Data 2D, 43, 4F, 44, 45, 0D  
( - C O D E )  
Output Sequence 02, 03, 01, 04

EXIT EDIT PROGRAMMING



- NO CHANGE IN OUTPUT
- MUST BE 10 DIGITS FOR EDIT



- **METHOD OF PROGRAMMING**

The CAPE features are programmed by first filling out the WorkSheet that is contained in the manual and then programming in the parameters via the Edit Parameter Menu.

The programming sequence involves steps in which you qualify the data as to what it is and how it was generated, then specify how it is to be divided into fields. After the input record definition, additional fields are defined and then the output sequence of all the fields.

- **TERMINOLOGY**

**INPUT RECORD** = Raw data received from a port.  
**FIELD** = A division of the Input Record.  
**ADDITIONAL FIELD** = Data not present in the Input Record, but to be present in the Output Record.  
**OUTPUT RECORD** = Data to be sent to the terminal.  
**FUNCTION CODES** = Keyboard depressions that cause a function to occur rather than data.  
Example: Data equals key entry of a, 1, T, B, 7, +, #, etc., where a function code equals key entry of TAB, CTRL, ENTER, F1, Up Arrow, etc.

- **PORTS**

**SCANNER PORT** = Input from the bar code port on the wedge. Accepts a digital signal from bar code scanning input devices.

**AUXILIARY PORT** = RS 232 input from a device (scale, portable terminal, etc.) attached to the auxiliary port on the wedge. Accepts ASCII data from RS 232 output devices attached to it.

**MAGNETIC PORT** = Input from a Magnetic Stripe Reader attached to the auxiliary port on the wedge.

- **SEQUENCE OF PROGRAMMING**

1) Scan ENTER EDIT PROGRAMMING

2) Specify Edit Number.

- a) A "01" Edit must always be specified.
- b) The "01" edit must always be the first edit.
- c) Maximum number of edits that can be defined are 31, or until all of the memory allocated for edit programming has been used.

3) DATA QUALIFIER: Specify Input Port

The first data qualifier is the port from which the input record will be received. Options include; Scanner, Auxiliary, Magnetic or ALL. If you do not care where the data was entered from, specify ALL.

4) DATA QUALIFIER: Specify Symbology

The Second data qualifier is the symbology that the record must be represented by.

If you know that the data can only be one specific code symbology, specify that symbology. If it does not matter what symbology the data is represented by, then indicate "ALL".

5) DATA QUALIFIER: Specify Input Record Length

The third data qualifier is the length of the input record (number of characters).

If length is not a qualifier, specify "00". The variable field length will be determined by the end of the input record or by the specifying a match code as the following field. The variable field will contain the data up to, but not including the match code field.

6) Specify Fields in the Input Record

The Input Record can be divided into multiple fields. Specify the total number of fields that will be defined.

7) Specify Input Field Length

Starting with the left most (high order) position of the input record, indicate the length of the field.

If the field is to be matched against a specific code, it should be defined as a Match Code. To do so, define a length of "01", specify in the Function Code Parameter the Hex Code to match and then scan "ON" to specify it as a Match Code.

8) Specify Function Code

A single (1) Function Code must be specified to follow a field. A Function Code may be any of the ASCII characters.

Example, a Function Code may be the character "A" or the digit "6" or a keyboard function such as "Field Forward".

If no Function Code is desired, specify "00". All Function Codes are defined using Key Codes. Reference Appendix C, Key Code Chart for a listing.

**NOTE: MATCH CODE**

If the field being defined is to be used as a Match Code Qualifier, the Function Code definition becomes the Key Code for the character to be matched.

9) OPTIONAL ENTRY: Specify Match Code

Any or all characters within an Input Record may be matched individually against a predetermined character.

If matching is NOT desired IGNORE this entry.

If matching is desired

- a) Input Field Length = 01
- b) Function Code = Hex Code to Match to
- c) Match Code = ON

**REPEAT ITEMS 7 - 9 UNTIL ALL FIELDS FOR THE INPUT RECORD HAVE BEEN DEFINED.**

10) Specify Number of Additional Fields

Fields may be added to the Output Record as desired. Indicate how many fields you wish to add. If NO Added Fields are desired scan in 00 and IGNORE 11 & 12.

11) Specify Additional Field Length

Specify the length (number of digits) that will be added in this field definition. Ignore this entry if there are NO Additional Fields.

12) Specify the Field to be Added

Using the ASCII Code Chart, indicate in Hexadecimal each character of the field to be added.

Example:       BAR CODE = 8 digits  
              42 41 52 20   43 4F 44 45  
              B A R Space C O D E

The number of characters entered MUST equal the Added Field Length given in Item 11. The maximum number of characters per field is 15. Ignore this entry if there are NO Additional Fields.

**REPEAT ITEMS 11 AND 12 UNTIL ALL ADDITIONAL FIELDS ARE DEFINED.**

13) Specify Output Record Sequence

Indicate the order in which the fields should be output. If a field is NOT to be included in the output record, do not include it in the sequence. Field Numbering: Input Fields start at 01. Added Fields start with the number immediately following the last Input Field.

Example:       6 Input Fields + 4 Added Fields

For Output Sequencing, the Input Fields are numbered 01 - 06 and the Added Fields are numbered 07 - 10.

14) Scan EXIT EDIT PROGRAMMING

**REPEAT STEPS 1 - 14 FOR ALL INPUT RECORDS REQUIRING AN EDIT.**

**NOTE:** For each Edit, you must first Enter Edit Programming and then Exit Edit Programming after each Edit is defined.

• **PROGRAMMING CONSIDERATIONS - GENERAL**

1. It is strongly advised that prior to attempting any CAPE programming that Section 9 be read in its entirety and that a worksheet be filled out.
2. Maximum number of Input Records that can be edited = 31, or until all memory allocated for edit programming is used.
3. A beep sequence of 4 Highs and 4 Lows indicates that you have exceeded the memory space available
4. Maximum number of Fields divisions per Input Record = 31.
5. Maximum Input Record Length = 32. The exception to this would be input from a Magnetic Stripe Reader.
6. Default = No Edits.
7. Must always scan in "ENTER" before each Input Record Edit.
8. Must always have a "01" Edit designated. Must always be the first edit entered.
9. Must always answer all options on the parameter menu in sequential order.
10. Must enter a two (2) digit code where defined.  
Example: Input Length of 3 = 0 and 3, not just 3.

- **PROGRAMMING CONSIDERATIONS - "IF" CONDITIONS**

1. Match Code is only programmed when needed.  
If Match Code = ON  
Then "Input Field Length" = 01  
Then "Function Code" = Hex Code to Match to
2. If NO Additional Fields are desired  
Then "Additional Fields" = 00 (must be entered)  
Then "Additional Field Length" & "Additional Field Data" parameters do not have to be entered.
3. If a Input Record is edited  
Then any Preambles and Postambles "WILL NOT" apply to the Input Record.
4. If a Function code is not desired  
Then "Function Code" = 00 (Null)
5. If any & all input is to be accepted  
Example:  
The unit is programmed to read only Code 128 from the Scanner Port, but varying lengths of Code 128 can be entered.  
Then "Input Record Length" = 00 (any length record)  
Then "Fields in Input Record" = 01  
Then "Input Field Length" = 00
6. If a Primary and Secondary output is being defined for an Input Record  
Then the Switch In Label must be the first edit "01".  
The Deactivate Switch Label must be the second edit "02".  
The Deactivate Switch Label is only used when you have entered Secondary output mode and then want to return to Primary output mode without reading a label designated for Secondary output.

- **DEFAULT SETTINGS**

To set default, scan the following sequence:

- 1) Enter Edit Selections
- 2) Default Edit Selections
- 3) Exit Edit Selections

This sets the unit to "NO EDITS". If record edits have been programmed they will be deleted.

- **TURNING ON & OFF EDITS**

Once the unit is programmed for a series of edits, those edits can be turned On and Off by scanning the following sequence. If the edits are turned off, they will remain in memory until they are turned back on or the unit is defaulted.

To Turn OFF - Scan the following

- 1) Enter Edit Selections
- 2) OFF
- 3) Exit Edit Selections

To Turn On - Scan the following

- 1) Enter Edit Selections
- 2) ON
- 3) Exit Edit Selections

- **TURNING ON & OFF INDIVIDUAL EDITS**

Once the unit is programmed for a series of edits, individual edits can be turned On and Off by scanning the following sequence. If an edit is turned off, it will remain in memory until it is turned back on or the unit is defaulted.

Example = Turn Off or On Edit # 03

To Turn OFF Edit 03 - Scan the following

- 1) Enter Edit Selections
- 2) 03
- 3) D

To Turn back ON Edit 03 - Scan the following

- 1) Enter Edit Selections
- 2) 03
- 3) E

- **ADDING AN EDIT**

Additional edits may be added at any time. New edit records must be given an Edit Number not already in use.

Example: If Edit Numbers 01, 05 and 07 have already been defined, you could define a new edit with an Edit Number of 02, or 03, or 08, or 10, etc., as long as the original Edit Numbers are not used.

- **REDEFINING AN EDIT**

Once an edit is already in memory, it can be redefined. It must be remembered that whatever edit number you start redefining on, all subsequent edits, no matter what the order of entry, must be reentered. The Edits are stored by order of entry, not in numerical sequence (Exception, the first edit entered must be 01).

- **ERROR RECOVERY**

If you know you have made an error in the entry of an edit you can:

- 1) Scan "Exit Edit Selections" and then reenter the edit from the beginning.
- 2) If you exit a programming procedure before all options have been answered, that edit number will not be saved.
- 3) Scan "OFF" until you get to a known correct entry. However, if you continue to scan "OFF" until you hear a series of beeps (1 High and 2 Low), you have reached the "Enter Edit Selections" bar code. If you reach this point, you must:
  - Scan "Exit Edit Selections"
  - Scan "Enter Edit Selections"
  - Scan "ON"
  - Scan "Exit Edit Selections"Restart your initial edit programming.

- **MAGNETIC INPUT CONSIDERATIONS**

Since Input Records from magnetic media can vary in length, special consideration must be given to it.

***EXACT RECORD LENGTH***

If the Record Length from the magnetic media is known (Example: Employee Badge), then the edit programming does not change.

**NOTE:** All Sentinels and Field Separators must be taken into account in the editing process.

***VARIABLE RECORD LENGTH***

If the Record Length from the magnetic media is variable (Example: Credit Cards), then the edit programming must allow for it. Program "Input Record Length" = 00 for known variable input. The unit will use the input data from the left most position that has not been edited up until the next Field Separator or Stop Sentinel or Match Code.

**Mag Stripe Input - Recognizing Sentinels & Separators**

When "G" is programmed for the Symbology, the unit will use the Start/Stop Sentinels and the Field Separators to define fields. The unit assumes that the Field Separators and the Stop Sentinel (that are standard in mag stripe data) are the stopping point for a variable length field.

Note that the Sentinels and Separators are still input as data that should be accounted for in the edit programming by indicating an Input Field Length of 01.

**Mag Stripe Input - Recognize End Sentinels Only**

When "E" is programmed for the Symbology, only the End Sentinel will be used to terminate the variable field length.

Note that the Sentinels and Separators are still input as data that should be accounted for in the edit programming by indicating an Input Field Length of 01. A match character may also be defined.

If you are programming more than one magnetic input record, either have one of the records programmed for a variable input length, or use a Match Code Edit to distinguish between the tracks.

If an area of the input data is known to be fixed in length, it can be specified as such.

Example: The Expiration Date can be either a four digit field or two fields of two digits in length.

***CARD OUTPUT SEQUENCE***

<u>Track(s)</u>	<u>Output Sequence</u>
1	1
2	2
1 & 2	2, 1

***CREDIT CARD INPUT***

**TRACK 1**

<u>Definition</u>	<u>Data</u>	<u>Input Field Length</u>
Start Sentinel	%	01
Format Code	B	01
Primary Account No	Numeric	00 (Variable)
Field Separator	^	01
Name	Alpha/Numeric	00 (Variable)
Field Separator	^	01
Expiration Date	YYMM	04
Additional Data	Numeric	00 (Variable)
Stop Sentinel	?	01

**TRACK 2:**

<u>Definition</u>	<u>Data</u>	<u>Input Field Length</u>
Start Sentinel	;	01
Primary Account No	Numeric	00 (Variable)
Field Separator	=	01
Expiration Date	YYMM	04
Additional Data	Numeric	00 (Variable)
Stop Sentinel	?	01

### PROGRAMMING EXAMPLE # 3

Magnetic Stripe Input From Credit Card (Track Two)

**INPUT RECORD** = ;1234567890123456=890810100000?

**OUTPUT RECORD** = 1234567890123456<ENTER>0889<ENTER>

ENTER EDIT PROGRAMMING

Edit Number	<b>01</b>
Port	<b>3</b> (Magnetic)
Symbology	<b>G</b> (All)
Input Record Length	<b>00</b> (Variable)
Fields In Input Record	<b>07</b>
Field 1:	
Input Field Length	<b>01</b> (;)
Function Code	<b>00</b> (Null)
Field 2:	
Input Field Length	<b>00</b> (Variable)
Function Code	<b>0D</b> (Enter)
Field 3:	
Input Field Length	<b>01</b> (=)
Function Code	<b>00</b> (Null)
Field 4:	
Input Field Length	<b>02</b> (89)
Function Code	<b>0D</b> (ENTER)
Field 5:	
Input Field Length	<b>02</b> (08)
Function Code	<b>00</b> (Null)
Field 6:	
Input Field Length	<b>00</b> (Variable)
Function Code	<b>00</b> (Null)
Field 7:	
Input Field Length	<b>01</b> (?)
Function Code	<b>00</b> (Null)
Added Fields:	<b>00</b>
Added Field Length	Ignore
Added Field Data	Ignore
Output Sequence	<b>02, 05, 04</b>

EXIT EDIT PROGRAMMING



**PROGRAMMING EXAMPLE # 4**

Primary and Secondary Output Formats: A Primary and Secondary Output Format actually defines two output formats for one input record. The second of the two output formats is activated by reading a "Switch Label".

**SWITCH LABEL:**

When programming for Primary and Secondary Output Records you must define a label that when read will activate the switching. The Switch label MUST be defined as EDIT "01". After indicating Edit #01, Scan "ON" to indicate that the Switch label is being defined. Then, use the Match Code identifiers to indicate the characters in the label that will be used for switching. Once switched, the unit will output the secondary record format on the next input record and then automatically switch back to primary output.

Only one Switch Label may be designated. Do not specify an output sequence for this record edit.

**DEACTIVATE SWITCH LABEL:**

When programming for Primary and Secondary Output Records you must define a label that when read will deactivate the switching. The deactivate or void switch would be used to return to primary output. After indicating Edit #02, Scan "ON" to indicate that the Deactivate Switch label is being defined. Then, use the Match Code identifiers to indicate the characters in the label that will be used for switching. Only one Deactivate Switch Label may be designated. Do not specify an output sequence for this record edit.

**SECONDARY EDIT DEFINITIONS:**

When a Secondary Edit is defined for a record, Scan "ON" immediately following the Edit Number of the Secondary Record. This indicates that when a Switch Label is read that the unit will search for a Secondary Output based on the Input Record qualifiers.

**SEQUENCE OF PROGRAMMING**

- Notes:** "01" edit must always be the first edit.
- "01" Edit must indicate the Switch In Label
- "02" Edit must indicate the Deactivate Switch Label.

INPUT RECORD: 129392844668374500001295

PRIMARY OUTPUT RECORD: 1293<TAB>92844<TAB>6683745<TAB>00001295<ENTER>

SECONDARY OUTPUT RECORD: 1293<TAB>92844<TAB>6683745<TAB>

SWITCH IN LABEL = X

DEACTIVATE SWITCH LABEL = A

ENTER EDIT PROGRAMMING BEFORE EACH EDIT

Edit Number:	<i>01</i>	<i>02</i>	<i>03</i>	<i>04</i>
Switch Label:	<i>ON</i>	<i>ON</i>		<i>ON</i>
Port:	<i>1</i>	<i>1</i>	<i>1</i>	<i>1</i>
Symbology:	<i>B</i>	<i>B</i>	<i>B</i>	<i>B</i>
Input Record Length:	<i>01</i>	<i>01</i>	<i>24</i>	<i>24</i>
Fields In Input Record:	<i>01</i>	<i>01</i>	<i>04</i>	<i>04</i>
F 1:				
Input Field Length:	<i>01</i>	<i>01</i>	<i>04</i>	<i>04</i>
Function Code:	<i>58 (X)</i>	<i>41 (A)</i>	<i>0B</i>	<i>0B</i>
Match Code:	<i>ON</i>	<i>ON</i>		
F 2:				
Input Field Length:			<i>05</i>	<i>05</i>
Function Code:			<i>0B</i>	<i>0B</i>
F 3:				
Input Field Length:			<i>07</i>	<i>07</i>
Function Code:			<i>0B</i>	<i>0B</i>
F 4:				
Input Field Length:			<i>08</i>	<i>08</i>
Function Code:			<i>0D</i>	<i>0D</i>
Added Fields:	<i>00</i>	<i>00</i>	<i>00</i>	<i>00</i>
Field Length:	Ignore	Ignore	Ignore	Ignore
Field Data:	Ignore	Ignore	Ignore	Ignore

Output Sequence: EDIT 01 = IGNORE  
 EDIT 02 = IGNORE  
 EDIT 03 = *01, 02, 03, 04*  
 EDIT 04 = *01, 02, 03*

EXIT EDIT PROGRAMMING AFTER EACH EDIT



Switch  
In Label

**X**



Deactive  
Switch

**A**



1 2 3 4 8 8 0 0 1 9 0 2 4 8 7 5 0 0 0 0 1 2 9 5



9 2 3 3 4 4 5 6 3 5 6 7 3 8 7 7 0 0 0 1 9 9 5 0

## XI. KEYBOARD REMAPPING

At default state, the unit will output the key codes associated with the following characters:

A - Z Upper Case, a - z Lower Case

0 - 9

Special Characters: ! " # \$ % & ' ( ) \* + , - . / : ; < = > ? @ [ \ ] ^ \_ { | } grave overscore DEL Space

These characters take up key code positions 20 through 7F. Reference Appendix C for a listing of the key code assignments.

Codes representing Function Key depressions are preassigned. These include "ENTER", "TAB", "NEW LINE", "F1", etc. Reference Appendix C for a listing of the key code assignments.

Keyboard remapping allows for the unit to be set-up by the user to emulate all keystrokes required for a particular application.

**NOTE:** Keyboard Remapping as described in this section only effects data input from the unit. Manual keyboard entry remains the same.

### • BASIC FUNCTIONS

- 1) Single Character Replacement
- 2) Swap Two Keys using the keyboard
- 3) Swap Two ASCII Characters
- 4) Multiple Key Function Record
- 5) Set Pause Time
- 5) Default Settings

#### 1. SINGLE CHARACTER REPLACEMENT

##### **Description:**

Allows the user to put a desired key at any ASCII location.

Shifted or unshifted keys can be used. However, shifted keys cannot be placed into key code positions 16 - 1F. These positions are reserved for multiple key functions. Unshifted keys can be placed into 16 - 1F as long as there is not a multiple key string already recorded there. See Multiple Key Function Record, Page 10 - 5.

**Typical Use:** Key Code 04 = Function Key 22

##### **Menu Implementation:**

1. Scan - ENTER KEYMAP SELECTIONS
2. Scan - SINGLE CHARACTER REPLACEMENT
3. Scan - The two (2) digit ASCII Location (01 – 7F)  
4 High Beeps will signal that the unit is ready for a keystroke
4. Depress the desired key on the keyboard.  
1 High, 1 Low Beep will signal a good read
5. For more entries, start at step 3 and repeat the process.
6. If finished, Scan - EXIT KEYMAP SELECTIONS.

**EXAMPLE:** Hex 30 (normally a "0")  
Output as a "-"

1. Scan - ENTER KEYMAP SELECTIONS
2. Scan - SINGLE CHARACTER REPLACEMENT
3. Scan - 30
4. Depress -
5. Scan - EXIT KEYMAP SELECTIONS.



**NOTE:** Manual depression of the "0" will still output "0".

## 2. SWAP TWO KEYS FROM THE KEYBOARD

### **Description:**

Allows the user via key depressions to change one key output to another. Shifted or unshifted keys can be used.

Key positions to be depressed must already be in the keycode table. If not, use Single Character Replacement for the swap.

### **Typical Use = Foreign Keyboard:**

Q = A, A = Q, T = Z, Z = T

### **Menu Implementation:**

1. Scan - ENTER KEYMAP SELECTIONS
2. Scan - SWAP TWO KEYS  
4 High Beeps will signal that the unit is ready for a keystroke
3. Depress the desired first key on the keyboard.  
1 High, 1 Low Beep will signal a good read
4. Depress the desired second key on the keyboard.  
1 High, 1 Low Beep will signal a good read
5. For more entries, start at step 2 and repeat the process.
6. If finished, Scan - EXIT KEYMAP SELECTIONS.

**EXAMPLE:** 5 = X

1. Scan - ENTER KEYMAP SELECTIONS
2. Scan - SWAP TWO KEYS
3. Depress - 5
4. Depress - Shift X
5. Scan - EXIT KEYMAP SELECTIONS.



**NOTE:** Manual depression of the "5" will still output "5" and manual depression of the "X" will still output "X".

### 3. SWAP TWO ASCII CHARACTERS

**Description:**

Allows the user to change one key output to another using only the programming menu.

ASCII locations must be known (01-1F). This function will not search the internal table for the key, so there is no problem with not finding the key as in previous functions.

**Menu Implementation:**

1. Scan - ENTER KEYMAP SELECTIONS
2. Scan - SWAP TWO ASCII CHARACTERS
3. Scan - The two (2) digit ASCII Location (01 - 7F) of the first key.
4. Scan - The two (2) digit ASCII Location (01 - 7F) of the second key.
5. For more entries, start at step 3 and repeat the process.
6. If finished, Scan - EXIT KEYMAP SELECTIONS.

**EXAMPLE:** HEX 31 = HEX 24 (1 = \$)

1. Scan - ENTER KEYMAP SELECTIONS
2. Scan - SWAP TWO ASCII CHARACTERS
3. Scan - 31
4. Scan - 24
5. Scan - EXIT KEYMAP SELECTIONS



**NOTE:** Manual depression of the "1" will still output "1" and manual depression of the "\$" will still output "\$".

### 4. MULTIPLE KEY FUNCTION RECORDS

**Description:**

Allows the user to record a sequence of keys, consecutive or simultaneously, at a specific key code Location (16 - 1F).

Limited to ASCII Locations 16 - 1F

10 Strings consisting of approximately 80 to 250 keys depending on the terminal in use.

Can be retrieved by :

- Scanning the appropriate Keyboard Function Record
- Programmed as a Preamble or Postamble
- Inserted when programmed into a CAPE Edit
- Enabled in a bar code

**Menu Implementation:**

- 1. Scan - ENTER KEYMAP SELECTIONS
- 2. Scan - MULTIPLE KEY FUNCTION RECORD
- 3. Scan - The two (2) digit ASCII Location (16 - 1F)  
4 High Beeps will signal that the unit is ready for a keystroke
- 4. Type - The keys in the desired order.  
Type slowly and firmly depress each key.
- 5. Scan - DISPLAY  
Shows how the key sequence was recorded  
If OK, Scan - STORE  
If NOT CORRECT, Scan - REDO and return to # 3
- 6. For more entries, start at step 3 and repeat the process.
- 7. If finished, Scan - EXIT KEYMAP SELECTIONS.

**EXAMPLE:** Hex 17 = TEST<TAB>1<ENTER>

- 1. Scan - ENTER KEYMAP SELECTIONS
- 2. Scan - MULTIPLE KEY FUNCTION RECORD
- 3. Scan - 17
- 4. Key In - TEST<TAB>1<ENTER>
- 5. Scan - DISPLAY  
If the display repeats what was keyed in step 4, Scan - **STORE**  
If Not, Scan - **REDO** and return to step 3
- 6. Scan - EXIT KEYMAP SELECTIONS
- 7. Scan - ENTER SCANNER PORT SELECTIONS
- 8. Scan - POSTAMBLE
- 9. Scan - 17
- 10. Scan - EXIT SCANNER PORT SELECTIONS

Each bar code read will output to the screen the bar code followed by "TEST<TAB>1<ENTER>  
or

In Appendix D, Scan the #23 bar code. This will also output to the screen "TEST<TAB>1<ENTER>.  
or

Program using a CAPE Edit to insert the Hex Code 17 into the middle of the bar code output.

Input = 01234 (5 Digit - Code 39)  
Output = 012TEST<TAB>1<ENTER>34<ENTER>

Edit = 01 Edit 01  
1 Scanner Port  
B Code 3 of 9  
05 Input Length = 05  
02 # of Fields = 02  
03 Field 1 = 3 Digits  
17 Add Hex 17 After Field 1  
02 Field 2 = 2digits  
0D Add <Enter> after field  
00 No Added Fields  
01 02 Output Sequence = 01, 02

**TYPICAL EXAMPLE:** Consecutive & Simultaneous Key Strokes

Hex 1F = <ALT T>002<Field Forward>

Hex 17 = <ESC \><ENTER>

**NOTE:**

If you are not able to program simple multiple key remaps the problem could be in the beeper timing. On certain Keyboards, the beep that follows a key depression interferes with the timing of the key depression. In order to avoid this, turn the key depression beep off.

1. Scan - ENTER KEYMAP SELECTIONS
2. Scan - OFF
3. Scan - EXIT KEYMAP SELECTIONS

**5. SET PAUSE TIME**

Allows the user to set ASCII Location 15 for PAUSE of 0 to 10 seconds.

When ASCII Location 15 is inserted into the output data record it will cause the unit to pause the programmed amount of time.

**Typical Use:**

Used when function codes such as "ENTER", "REC ADV", or "XMIT" are inserted into the output record. These key functions normally cause a screen change during the output of data.

If these functions are embedded within the output of a record via a programmed edit, there is a possibility of data loss if the host systems response time is slower then the units transmission speed.

If a "PAUSE" is inserted after the function, the unit will hold the remainder of data to be output in buffer and continue transmission at the end of the pause.

**Menu Implementation:**

1. Scan - ENTER KEYMAP SELECTIONS
2. Scan - SET PAUSE TIME
3. Scan - The two (2) digits (00 - 99) to represent the length of time for the pause.
4. Scan - EXIT KEYMAP SELECTIONS

**NOTE:** The number scanned will be multiplied by 100 milliseconds.  
10 = 1000 milliseconds or 1 second, 80 = 8000 milliseconds or 8 seconds

**Example:**

1. Scan - ENTER KEYMAP SELECTIONS
2. Scan - SET PAUSE TIME
3. Scan - 20 (20 = 2 Seconds)
4. Scan - EXIT KEYMAP SELECTIONS
5. Scan - ENTER SCANNER PORT Selections
6. Scan - POSTAMBLE
7. Scan - 0D 15 (NEW LINE & PAUSE)
8. Scan - EXIT SCANNER PORT Selections

If a series of bar codes are read, the unit will output after each bar code the NEW LINE Key and then pause for 2 seconds before sending the next bar code read.

## 6. DEFAULT SETTINGS

**DEFAULT** = Normal ASCII Output.  
Reference Appendix C for key code locations

### **DEFAULT TO NORMAL KEYBOARD OUTPUT**

1. Scan - ENTER KEYMAP SELECTIONS
2. Scan - DEFAULT
3. Scan - EXIT KEYMAP SELECTIONS

### **DEFAULT INDIVIDUAL ASCII LOCATIONS**

1. Scan - ENTER KEYMAP SELECTIONS
2. Scan - DEFAULT
3. Scan - 2 Digit ASCII Location
4. Scan - EXIT KEYMAP SELECTIONS or another 2 Digit ASCII Location



## XII. STATUS CHECK

This menu page allows the user to display the Status of the parameter selections that have been programmed into the unit.

### Status Display Notes:

1. When displaying the Status to the terminal, the operator should start with a clear screen, as the data displayed will take up most of the screen.
2. The scanning of an EXIT symbol is not required, however, an EXIT symbol is on the page in the event you ENTER the Status Check and then decide to Exit without displaying any of the parameters.

The user may choose to transmit the status to either the terminal it is attached to, or transmit the data via the RS 232 Port to an external RS 232 device such as a printer.

### The user may choose to display:

- The configuration for General/Auxiliary/Scanner which includes the following menu pages.

Revision Level of Unit		
Terminal ID		
General I	Serial I	Scanner Port
General II	Serial II	
	Serial III	

- The configuration for Bar Code Selections which include the following menu pages.  
Industrial Codes                      Retail Codes
- The configuration for any programmed CAPE Edits.
- The Keyboard Remap configuration.

**STATUS DISPLAYS WITH DEFAULT SET**

**1. GENERAL I & II, SERIAL I, II, III, SCANNER**

**SCAN:**

- ENTER STATUS CHECK
- TO TERMINAL
- A

**DISPLAY:**

QUICKLINK 501.01

*(Model & Firmware Revision Level)*

TERMINAL ID..00

**\*\* GENERAL I \*\***

BEEPER VOLUME.. 7

INPUT INHIBIT CHECK.. DISABLED

KYBD TYPE.. A

INTER CHAR DELAY.. 00

INTER FUNCTION DELAY.. 00

**\*\* GENERAL II \*\***

AUX PORT ENB.. MSR TRACK 2

BUFFERS.. ENABLED

SOLICIT REC..

SWITCH.. 00000000

**\*\* SCANNER \*\***

PREAMBLE...

POSTAMBLE..

BEAM REDUNDANCY.. DISABLED

KFC.. DISABLED

CODE ID.. DISABLED

**\*\* SERIAL I \*\***

PREAMBLE...

POSTAMBLE..

RECORD TERMINATOR.. CR

KFC.. DISABLED

INTER CHAR DELAY.. 00

INTER FUNCTION DELAY.. 00

**\*\* SERIAL II \*\***

BAUD RATE..9600

PARITY..EVEN

DATA BITS..7

STOP BITS.. 1

PROTOCOL..REC

**\*\* SERIAL III \*\***

DUAL PORT..DISABLED

BUFFER MODE..REC

PROTOCOL..READY

DATA XMIT...HOST

FIXED LEN MSG..DISABLED

## 2. BAR CODE CONFIGURATION

### SCAN:

- ENTER STATUS CHECK
- TO TERMINAL
- B

### DISPLAY:

QUICKLINK 501.01 (Model & Firmware Revision Level)  
CODABAR  
MIN LGH 00  
MAX LGH 64  
CODE 39 FULL ASCII  
MIN LGH 00  
MAX LGH 64  
I 2-OF-5  
MIN LGH 04  
MAX LGH 64  
ID 2-OF-5  
MIN LGH 04  
MAX LGH 64  
CODE 128  
MIN LGH 00  
MAX LGH 64  
CODE 11 TWO CK DGT                      CODE 93  
MIN LGH 00                                      MIN LGH 00  
MAX LGH 64                                      MAX LGH 64  
UPC-A    UPC-E    2 SUP    5 SUP    CHK OUT NUM SYS  
EAN-8    EAN-13    2 SUP    5 SUP

Note: Under a default setting Plessey and Codablock are OFF and are not included in the above listing.

### 3. STATUS DISPLAYS WITH 2 SAMPLE EDITS

#### SCAN:

- ENTER EDIT STATUS CHECK
- TO TERMINAL

#### DISPLAY:

The first edit will display.

For subsequent Edits, Repeat the above procedure.

#### EDIT 01

QUICKLINK 501.01 (Model & Firmware Revision Level)

EEROM CAP EDIT

EDIT .. 01

PORT .. SCANNER

SYMBOLGY .. CODE 39

INPUT LENGTH 08

INPUT FLDS.. 03

LENGTH FC

(FLD 01) 01 4E MATCH

(FLD 02) 04 0B

(FLD 03) 03 01

ADDED FLDS.. 00

OUTPUT SEQ.. 02 03

-- MORE --

#### EDIT 02

QUICKLINK 501.01 (Model & Firmware Revision Level)

EEROM CAP EDIT

EDIT .. 02

PORT .. MAGNETICS

SYMBOLGY .. ALL AUX MAGNETICS

INPUT LENGTH 00 VARIABLE

INPUT FLDS.. 07

LENGTH FC

(FLD 01) 01 00

(FLD 02) 00 01

(FLD 03) 01 00

(FLD 04) 02 01

(FLD 05) 02 00

(FLD 06) 00 00

(FLD 07) 01 00

ADDED FLDS.. 00

OUTPUT SEQ.. 02 05 04

\*\* END EDITS \*\*

#### 4. KEYBOARD REMAP CONFIGURATION

**SCAN:**

- ENTER STATUS CHECK
- TO TERMINAL
- C

**DISPLAY:**

QUICKLINK 501.01 (Model & Firmware Revision Level)  
TERMINAL ID...XX  
\*\* KEYBOARD REMAPPING \*\*  
NO REMAPPING EXISTS

**EXAMPLE: STATUS DISPLAYS WITH REMAP**

TURBO 2 - XXX.XX (Model & Firmware Revision Level)  
TERMINAL ID...XX  
\*\* KEYBOARD REMAPPING \*\*  
REMAPPING EXISTS FOR ID..XX  
\*\* SINGLE CHARACTER REPLACEMENT \*\*

---

DEFAULT: & s w P S W !  
REMAPPED: p W S 7 w s P

---

\*\* MULTIPLE KEY FUNCTION RECORDS \*\*

16 ^L^B

17 TEST<TAB>ONE

18 ---

19 ---

1A ---

1B ---

1C ---

1D ---

1E ---

1F ---

TOTAL BYTES AVAILABLE = 1572 OF 1610

## Appendix A: INTERFACES – QuickLink 501

Manufacturer	Terminal Type	ID #	Cable #	Power Required	Comments	Primary Keyboard	Secondary Keyboard
ADDS	1010	19	0225044	PWR REQ		/CAPLK	CAPLK
APPLE	MAC IIci	29	0225050			/CAPLK	CAPLK
APPLE	MAC ES/30	29	0225050		←	/CAPLK	CAPLK
APPLE	MAC PwrBook	29	0225050		←	/CAPLK	CAPLK
APPLE	QUADRA 700	29	0225050		←	/CAPLK	CAPLK
ATT	605	01	0225013			/CAPLK	CAPLK
ATT	610/615	21	0225015		←	T/W	103
ATT	715/615 EM	12	0225015		←	T/W	
ATT	705/715 MT	28	0225036			T/W	
ATT	4410	26	0225015			T/W	
ATT	4425	27	0225015		←	/CAPLK	CAPLK
ATT	6386/PC	01	0225036		←	/CAPLK	CAPLK
ATT	6386/SX	01	0225036			/CAPLK	CAPLK
ATT	6286 EL	01	0225036		←	/CAPLK	CAPLK
ATT	6500	13	0225015		←	T/W	
ATT	6528	13	0225015		←	T/W	
ATT	6529	13	0225015		←	T/W	
AST	Notebook PC	18	0225080		w/o Ext Keyboard	/CAPLK	CAPLK
AST	Notebook PC	01	0225036		← with Ext Keyboard Switch 6 = ON	/CAPLK	CAPLK
CPU LABS INT'L	C-LINK 196E	64	0225013			/CAPLK	CAPLK
DATA GEN	214/215/217	45	0225024			/CAPLK	CAPLK
DATA GEN	6500	45	0225024		←	/CAPLK	CAPLK
DATA GEN	412	45	0225024		PC KYBD = ID 44	/CAPLK	CAPLK
DATA GEN	1200 I	01	0225036		←	/CAPLK	CAPLK
DATA GEN	5220 MTX	40	0225073			/CAPLK	CAPLK
DEC-DIGITAL	220,240	15	0225017			T/W	
DEC-DIGITAL	320,330	15	0225017			T/W	
DEC-DIGITAL	420	15	0225017			T/W	
DEC-DIGITAL	510/520	01	0225036		←	/CAPLK	CAPLK
DECISION DATA	386	08	0225013		←	/CAPLK	CAPLK
DECISION DATA	387C	08	0225013		←	/CAPLK	CAPLK
DECISION DATA	3496	59	0225008			T/W	
DECISION DATA	3496	59	0225043		IP/IH (0221021)	T/w	
DECISION DATA	3497	09	0225008			T/W	
DECISION DATA	3596/97- 83K	62	0225034	PWR W/LASER		/SHLK	SHLK
DECISION DATA	3596/97- 83K	62	0225042	PWR W/LASER	IP/IH (0221021)	/SHLK	SHLK
DECISION DATA	3596/97-102K	63	0225034	PWR W/LASER		/CAPLK	CAPLK
DECISION DATA	3596/97- 102K	63	0225042	PWR W/LASER	IP/IH (0221021)	/CAPLK	CAPLK
DECISION DATA	3596/97-122K	60	0225034	PWR W/LASER		/CAPLK	CAPLK
DECISION DATA	3596/97-122K	60	0225042	PWR W/LASER	IP/IH (0221021)	/CAPLK	CAPLK
DECISION DATA	3596-3776K	80	0225034	PWR W/LASER		T/W	
DECISION DATA	3597- 83K	62	0225034	PWR W/LASER	←	/SHLK	SHLK

## Appendix A: INTERFACES – QuickLink 501

Manufacturer	Terminal Type	ID #	Cable #	Power Required	Comments	Primary Keyboard	Secondary Keyboard
DECISION DATA	3597- 83K	62	0225042	PWR W/LASER	← IP/IH (0221021)	/SHLK	SHLK
DECISION DATA	3597-122K	60	0225034	PWR W/LASER	←	/CAPLK	CAPLK
DECISION DATA	3597-122K	60	0225042	PWR W/LASER	← IP/IH (0221021)	/CAPLK	CAPLK
DECISION DATA	3761	10	0225014		IP/IH (0221021)	T/W	
DECISION DATA	3776	36	0225085			/CAPLK	CAPLK
DECISION DATA	3777	36	0225085			/CAPLK	CAPLK
DECISION DATA	IS 386	36	0225085		←	/CAPLK	CAPLK
DECISION DATA	3781	04	0225008			T/W	D/E
DECISION DATA	3791	10	0225014		IP/IH	T/W	
DELL	210 PC	01	0225036			/CAPLK	CAPLK
EPSON	PC	01	0225036			/CAPLK	CAPLK
ESPRIT	200/400	01	0225036		←	/CAPLK	CAPLK
GATEWAY	2000	01	0225036		←	/CAPLK	CAPLK
GRID LAPTOP	1450 SX	01	0225013		←	/CAPLK	CAPLK
HARRIS	WS 471/472	03	0225013		←	/CAPLK	CAPLK
HARRIS	NV 481/482	03	0225013		←	/CAPLK	CAPLK
HP	700/92	61	0225034			/CAPLK	CAPLK
HP	700/94	61	0225034		←	/CAPLK	CAPLK
HP	700/41	61	0225034		←	/CAPLK	CAPLK
HP	700/43	68	0225089	PWR REQ		/CAPLK	CAPLK
HP	700/60	43	0225034	PWR REQ		/CAPLK	CAPLK
HP	700/96	61	0225034	PWR REQ		/CAPLK	CAPLK
HP	2392A	42	0225082			/CAPLK	CAPLK
HP	2624B	46	0225074			/CAPLK	CAPLK
HP	VECTRA	41	0225013			/CAPLK	CAPLK
HP	HIL	65	0225088		Each Leg = Male	/CAPLK	CAPLK
HP	HIL	65	0225004		Male & Female Leg	/CAPLK	CAPLK
HONEYWELL	HDS-7	23	0225013			T/W	
IBM	PC/XT	00	0225013			/CAPLK	CAPLK
IBM	PC-AT	01	0225013			/CAPLK	CAPLK
IBM	PC/XT	00	0225100	PWR REQ	1'=Kybd, 4'=Term	/CAPLK	CAPLK
IBM	PC/XT	00	0225100	PWR REQ	2'=Kybd, 2'=Term	/CAPLK	CAPLK
IBM	PC/XT	00	0225013		W/O Kybd + 0225003	/CAPLK	CAPLK
IBM	PS/2 50-80	01	0225036			/CAPLK	CAPLK
IBM	PS/2 25, 30	24	0225036			/CAPLK	CAPLK
IBM	PS/2 30/386	01	0225036			/CAPLK	CAPLK
IBM	PS/1	01	0225036		←	/CAPLK	CAPLK
IBM	LAPTOP 70	01	0225003			/CAPLK	CAPLK
IBM	3151	22	0225031	PWR W/LASER		102	
IBM	3153	01	0225046	PWR W/LASER		/CAPLK	CAPLK
IBM	3161	02	0225011			102	
IBM	3163	02	0225011			102	
IBM	3179-1	03	0225011		IP/IH (0221021)	T/W	D/E
IBM	3179-2	04	0225011		IP/IH (0221021)	T/W	
IBM	3180-1	05	0225011		IP/IN (0221021)	122	102

## Appendix A: INTERFACES – QuickLink 501

Manufacturer	Terminal Type	ID #	Cable #	Power Required	Comments	Primary Keyboard	Secondary Keyboard
IBM	3180-2	06	0225011		IP/IN (0221021)	T/W	D/E
IBM	3191	07	0225011			122	102
IBM	3192	07	0225011		←	122	102
IBM	3196	08	0225011			122	102
IBM	3197	25	0225011		IP/IH (0221021)	122	102
IBM	3471/3482	03	0225031		←	T/W	
IBM	3472	03	0225031			T/W	D/E
IBM	3476/78	08	0225031			122	102
IBM	3477	08	0225031		I/C = 03	122	102
IBM	3481	08	0225031			122	102
IBM	3481	34	0225081		IP/IH (022121)	122	102
IBM	3486/87	08	0225031		I/C = 02	122	102
IBM	3486/87	08	0225081		I/C = 02, IP/IH (0221021)	122	102
IBM	7546 PC	24	0225013		←	/CAPLK	CAPLK
IDEA/COURIER	486	08	0225090	PWR REQ		122	102
I/O	2677 C/D	08	0225036			/CAPLK	CAPLK
I/O	2676 D	08	0225036			/CAPLK	CAPLK
LIBERTY	120	50	0225048			ENH/ASCII	DEC
LINK	MC-5 105K	52	0225019		←	SHLK	CAPLK
LINK	MC-70 105K	51	0225019	PWR REQ	←	/CAPLK	CAPLK
LINK	MC-70 PCH	53	0225019	PWR REQ	←	/CAPLK	CAPLK
LINK	MC-70 ASCII	55	0225019	PWR REQ	←	/CAPLK	CAPLK
LYNK	096	00	0225035			/CAPLK	CAPLK
LYNK	096	00	0225013			83	
LYNK	196/E	00	0225035			/CAPLK	CAPLK
LYNK	196/E	00	0225013			83K	
LYNK	197/C/D	00	0225035			/CAPLK	CAPLK
LYNK	197/C/D	00	0225013			83K	
LYNK	LITE 1/2/3	00	0225035			/CAPLK	CAPLK
LYNK	LITE III M	17	0225013	PWR REQ		/CAPLK	CAPLK
LYNK	LYTE 87A	69	0225013	PWR REQ		122	
MAI BASIC IV	1200	01	0225013			/CAPLK	CAPLK
MAI BASIC IV	1400	01	0225013			/CAPLK	CAPLK
MAI BASIC IV	1800	01	0225013			/CAPLK	CAPLK
MAI BASIC IV	DT 4313	16	0225045			T/W	
MEMOREX	1196	08	0225013			T/W	
MEMOREX	1475	08	0225013			T/W	
MEMOREX	2192	30	0225013			T/W122	D/E122
NEC-Powermate	SX20I	66	0225013			/CAPLK	CAPLK
NCD	14C	01	0225036		←	/CAPLK	CAPLK
NCD	15B	01	0225036		←	/CAPLK	CAPLK
NCD	16,16E	01	0225036		←	/CAPLK	CAPLK
NCD	17C	01	0225036		←	/CAPLK	CAPLK
NCD	19,19B,19C	01	0225036		←	/CAPLK	CAPLK
PRIME	PT 250	72	0225057			\CAPLK	CAPLK



## Appendix A: INTERFACES – QuickLink 501

Manufacturer	Terminal Type	ID #	Cable #	Power Required	Comments	Primary Keyboard	Secondary Keyboard
QUME	321	33	0225086			\CAPLK	CAPLK
QUME	QX-15	70	0225086	PWR REQ		\CAPLK	CAPLK
QUME	QVT-82	70	0225086	PWR REQ	←	\CAPLK	CAPLK
RS 232		31	↑	Yes	Aux Port Interface		
RS 232		XX	↑	Yes	Dual Port Interface		
SHERWOOD	7000ST	00	0225056			/CAPLK	CAPLK
STRATUS	V-103 105K	51	0225019	PWR REQ	←	/CAPLK	CAPLK
STRATUS	V-103 PCENH	53	0225019	PWR REQ	←	/CAPLK	CAPLK
STRATUS	V-103 ASCII	55	0225019	PWR REQ	←	/CAPLK	CAPLK
SUN CLASSIC	4/375	74	0225001			/CAPLK	CAPLK
TEKTRONIX XP	358/29/220	01	0225036		←	/CAPLK	CAPLK
TELEX	191	07	0225013			T/W	D/E
TELEX	78X - 80X	03	0225013			T/W122	D/E122
TELEX	1192	02	0225013			T/W	D/E
TELEX	1196	08	0225013			T/W	D/E
TELEX	1197	25	0225013			T/W	D/E
TELEX	1476	08	0225013			T/W	D/E
TOSHIBA	T4400SX	14	0225049			/CAPLK	CAPLK
UNISYS	T-27	58	0225030			/CAPLK	CAPLK
UNISYS	B-26	57	0225030			T/W	
UNISYS	SG 2500	57	0225030			T/W	
VISENTECH	VS 220	49	0225051			/CAPLK	CAPLK
WANG	2110/2110A	35	0225038			105 K	101 K
WANG	423A	71	0225038			105 K	101 K
WYSE	30	54	0225019	PWR REQ		/CAPLK	CAPLK
WYSE	50	47	0225025			/CAPLK	CAPLK
WYSE	75	48	0225025			/CAPLK	CAPLK
WYSE	85	52	0225019			SHLK	CAPLK
WYSE	60 PC ENH	56	0225019	PWR REQ		/CAPLK	CAPLK
WYSE	105K ANSI	51	0225019	PWR REQ		/CAPLK	CAPLK
WYSE	PC ENHANCED	53	0225019	PWR REQ		/CAPLK	CAPLK
WYSE	ASCII	55	0225019	PWR REQ		/CAPLK	CAPLK
WYSE	108K	67	0225019	PWR REQ		/CAPLK	CAPLK
WYSE	370 - 105K ANSI	51	0225018	PWR REQ		/CAPLK	CAPLK
WYSE	370 - PC ENH	53	0225018	PWR REQ		/CAPLK	CAPLK
WYSE	370 - ASCII	55	0225018	PWR REQ		/CAPLK	CAPLK
WYSE	370 - 108K	67	0225018	PWR REQ		/CAPLK	CAPLK

← = User tested, unconfirmed by Compsee Engineering

↑ = Cable defined per customer requirements

## Appendix A: INTERFACES – QuickLink 601

Manufacturer	Terminal Type	ID #	Cable #	Power Required	Comments	Primary Keyboard	Secondary Keyboard
APPLE	MAC IIci	29	0225050			/CAPLK	CAPLK
FUJITSU	7770	38	0225021		030 PARALLEL	N/A	N/A
FUJITSU	7990	40	0225021		030 PARALLEL	N/A	N/A
FUJITSU	ATRIUM	38	0225083		030 PARALLEL	N/A	N/A
IBM	PC-XT	00	0225013			/CAPLK	CAPLK
IBM	PC-AT	01	0225013			/CAPLK	CAPLK
IBM	PS/2 50-80	01	0225036			/CAPLK	CAPLK
IBM	PS/2 25, 30	24	0225036			/CAPLK	CAPLK
IBM	PS/2 30/386	01	0225036			/CAPLK	CAPLK
IBM-POS	3653	44	0225029			TELE	CALC
IBM-POS	3683	43	0225023		48 KEYS	TELE	CALC
IBM-POS	3683	51	0225023		35 KEYS	TELE	CALC
IBM-POS	4683-Pt 5B	45	0225027			N/A	N/A
IBM-POS	4683-Pt 17	45	0225012			N/A	N/A
NCR-POS	280	52	0225028			TELE	CALC
NCR-POS	2151	36	0225047			TELE	CALC
NCR-POS	2152	37	0225048			TELE	CALC
NCR-POS	2154	39	0225016			TELE	CALC
NCR-POS	2155	39	0225016			TELE	CALC
NCR-POS	7052-32K	61	0225032	PWR REQ		TELE	CALC
NCR-POS	7052-58K	61	0225032	PWR REQ		TELE	CALC
NCR-POS	7052-109K	60	0225032	PWR REQ		/CAPLK	CAPLK
RS 232		31	↑	Yes	Aux Port Interface		
RS 232		XX	↑	Yes	Dual Port Interface		

← = User tested, unconfirmed by Compsee Engineering

↑ = Cable defined per customer requirements

**Appendix A: RS 232 INTERFACES – QuickLink 501/601**

<b>CABLE #</b>	<b>CONNECTOR TYPE</b>	<b>TERMINAL CONNECTOR</b>	<b>COMPSEE CABLE HOST CONNECTOR</b>	<b>COMPSEE CABLE COMMENTS</b>	<b>GENERAL II AUXILIARY PORT PARAMETER</b>
0225005	DB 25	FEMALE	MALE	DCE, S/R, NO CTRL	MAG STRIPE ONLY
0225006	DB 25	MALE	FEMALE	DCE, S/R	MAG STRIPE ONLY
0225007	DB 25	FEMALE	MALE	DCE, S/R	MAG STRIPE ONLY
0225009	DB 25	MALE	FEMALE	DCE, S/O	RS 232 ONLY
0225010	DB 25	FEMALE	MALE	DCE, S/O	RS 232 ONLY
0225037	DB 25	FEMALE	*****	DCE, S/O, S/P, DTR	RS 232 ONLY
0225039	DB 25	MALE	MALE	DCE, S/R	MAG STRIPE ONLY
0225040	DB 25	FEMALE	*****	DCE, S/O, S/P	RS 232 ONLY
0225041	DB 25	FEMALE	*****	DTE, S/O, S/P	MAG STRIPE ONLY
0225052	DB 9	FEMALE	MALE	DCE, S/R	MAG STRIPE ONLY
0225077	DB 25	FEMALE	*****	DTE, S/O, S/P	RS 232 ONLY
0225079	DB 9	FEMALE	*****	DTE, S/O, S/P	RS 232 ONLY

**RS 232 CABLE NOTES:**

1. For Correct Cable Configuration, Send to Compsee Customer Support the terminal to host interface requirements and pin-outs.
2. Power Supply required when interfacing via the RS 232 Communications Line.
3. S/R = Send / Receive Type Cable.  
Required with XON/XOFF Protocol.
4. S/O = Send Only Type Cable.  
General II AUX Port Parameter must be programmed for RS 232 prior to programming Serial III Dual Port.
5. S/P = Single Port Type Cable.  
Serial III Transmit Direction is determined by the Compsee Cable Connector heading.
6. DCE or DTE refers to equipment the Compsee cable is being connected with.  
Dual Cables = Host.

← = User tested, unconfirmed by Compsee Engineering  
 ↑ = Cable defined per customer requirements

## **Appendix B: BEEP SEQUENCES**

After each successful read the unit will emit an audible tone. The volume of the tone emitted can be programmed within a range of 0 (OFF) to 7 (HIGH).

However, during any of the Programming Modes, the beeper will always return to a HIGH (7) volume to insure that the operator is aware of any problem that may occur.

Below is a list of beeper sequences and their meaning.

<b><u>BEEP SEQUENCE</u></b>	<b><u>MEANING</u></b>
2 HIGH	Power- Up Initialization
1 HIGH	Good Read (Data Entry Mode)
2 LOW, or More	Bad Read (or Buffers Full)
1 HIGH, 1 LOW	Good Read in Programming
1 HIGH, 2 LOW	Record Out Of Sequence in Program Mode
2 HIGH, 1 LOW	Subsequent Block Transmitted to the Host
4 HIGH	Keyboard Entry Required
4 HIGH, 3 LOW	Last Block Transmitted
4 HIGH, 4 LOW	Memory allocated for Edits has been exceeded

## Appendix C: KEY CODE CHARTS

When programming the unit to emulate data entry into an existing application, it is often necessary to insert additional digits, characters or function keys (Enter, Tab, ALT C, etc.)

The following key codes are used when programming preambles, postambles, edits or scale solicits. The program can call for the transmission of specific keys either one at a time, or in sequence. They are also used in an Edit sequence to define the character or character to match against.

### Key Code Table Information:

- **Definition**  
Gives the definition for the key either as a character or as a keyboard function.
  
- **Program Code**  
A two digit code used to define the character in the programming sequence.  
Example:           41 = A  
                      09 = Tab or Field Forward  
                      2B = + (Plus)  
                      C8 = PF9, CMD 9 or F9
  
- **Code 3 of 9**  
The character or sequence of characters that are needed if the key depression is to be embedded in a Code 3 of 9 Bar Code.  
Example:           Bar Code Input -           12345\$I  
                      Output to Terminal -       12345<Tab>  
                      Bar Code Input -           00/J9384+C\$M  
                      Output to Terminal -       00\*9384c<CR>

### NOTES:

- 1) The Keyboard Function Code menu selection for the scanner port must be turned on.
- 2) If the Keyboard Function Code selection is OFF, and Code 3 of 9 Full ASCII is ON -
  - the 2 digit character sequences representing function codes will be ignored.
  - the 2 digit character sequences representing characters will be transmitted correctlyExample:           Bar Code Input -           12345\$I67/J890  
                      Output to Terminal -       1234567\*890  
  The \$I representing the Tab key was ignored.
- 3) If the Keyboard Function Code selection is OFF, and Code 3 of 9 Full ASCII is OFF -  
All characters will be transmitted individually.  
Example:           Bar Code Input -           12345\$I67/J890  
                      Output to Terminal -       12345\$I67/J890

### IMPORTANT:

Do not embed within a data record those keyboard functions that will cause a system inhibit condition before the remainder of the record is sent to the terminal. Loss of data will result.

ASCII Definition	Prog. Code	Code 3 of 9	ASCII Definition	Prog. Code	Code 3 of 9
Null	00	%U	Sp space	20	SP
SOH	01	\$A	! exclam	21	/A
STX	02	\$B	“ quote	22	/B
ETX	03	\$C	# number	23	/C
EOT	04	\$D	\$ dollar	24	/D
ENQ	05	\$E	% percent	25	/E
ACK	06	\$F	& amprsnd	26	/F
BEL	07	\$G	^ acute	27	/G
BS	08	\$H	( op paren	28	/H
HT	09	\$I	) cl paren	29	/I
LF	0A	\$J	* asterisk	2A	/J
VT	0B	\$K	+ plus	2B	/K
FF	0C	\$L	, comma	2C	/L
CR	0D	\$M	- minus	2D	-
SO	0E	\$N	. period	2E	.
SI	0F	\$O	/ slash	2F	/O
DLE	10	\$P	0 0	30	0
DC1	11	\$Q	1 1	31	1
DC2	12	\$R	2 2	32	2
DC3	13	\$S	3 3	33	3
DC4	14	\$T	4 4	34	4
NAK	15	\$U	5 5	35	5
SYN	16	\$V	6 6	36	6
ETB	17	\$W	7 7	37	7
CAN	18	\$Y	8 8	38	8
EM	19	\$Z	9 9	39	9
SUB	1A	\$Z	: colon	3A	/Z
ESC	1B	%A	; semicln	3B	%F
FS	1C	%B	< ls than	3C	%G
GS	1D	%C	= equal	3D	%H
RS	1E	%D	> gt than	3E	%I
US	1F	%E	? questn	3F	%J

ASCII Definition		Prog. Code	Code 3 of 9	ASCII Definition		Prog. Code	Code 3 of 9
@	at sign	40	%V	'	grave	60	%W
A	Up case	41	A	a	Lw case	61	+A
B	Up case	42	B	b	Lw case	62	+B
C	Up case	43	C	c	Lw case	63	+C
D	Up case	44	D	d	Lw case	64	+D
E	Up case	45	E	e	Lw case	65	+E
F	Up case	46	F	f	Lw case	66	+F
G	Up case	47	G	g	Lw case	67	+G
H	Up case	48	H	h	Lw case	68	+H
I	Up case	49	I	i	Lw case	69	+I
J	Up case	4A	J	j	Lw case	6A	+J
K	Up case	4B	K	k	Lw case	6B	+K
L	Up case	4C	L	l	Lw case	6C	+L
M	Up case	4D	M	m	Lw case	6D	+M
N	Up case	4E	N	n	Lw case	6E	+N
O	Up case	4F	O	o	Lw case	6F	+O
P	Up case	50	P	p	Lw case	70	+P
Q	Up case	51	Q	q	Lw case	71	+Q
R	Up case	52	R	r	Lw case	72	+R
S	Up case	53	S	s	Lw case	73	+S
T	Up case	54	T	t	Lw case	74	+T
U	Up case	55	U	u	Lw case	75	+U
V	Up case	56	V	v	Lw case	76	+V
W	Up case	57	W	w	Lw case	77	+W
X	Up case	58	X	x	Lw case	78	+X
Y	Up case	59	Y	y	Lw case	79	+Y
Z	Up case	5A	Z	z	Lw case	7A	+Z
[	Op brkt	5B	%K	{	op brace	7B	%P
\	lft slash	5C	%L		vert rule	7C	%Q
]	cl brkt	5D	%M	}	cl brace	7D	%R
^	Circumf x	5E	%N	~	overscore	7E	%S
_	Und line	5F	%O		del	7F	

## Appendix D: KEYBOARD FUNCTION RECORDS

Keyboard Function Records are used to manipulate the cursor on the display and to cause the terminal to enter modes of operation that ordinarily require a keystroke.

Keyboard Function Record are defined as three-byte (ASCII characters) records that when scanned will emulate the keyboard function to the terminal. To use the Keyboard Functions Records, extended code 3 of 9 must be enabled.

### Bar Code



# 0 1



# 0 2



# 0 3



# 0 4



# 0 5



# 0 6



# 0 7



# 0 8

### Bar Code



# 0 9



# 1 0



# 1 1



# 1 2



# 1 3



# 1 4



# 1 5



# 1 6



Bar Code



# 1 7



# 1 8



# 1 9



# 2 0



# 2 1



# 2 2



# 2 3



# 2 4

Bar Code



# 2 5



# 2 6



# 2 7



# 2 8



# 2 9



# 3 0



# 3 1

## Keyboard Functions Supported

**A = Hex Code**

**B = Keyboard Function Code**

**C = Keyboard Function Record**

Column 1	Column 2	Column 3	Column 4	Column 5
<b>IBM – PC, PC/AT</b> PC/AT, LapTop <b>ATT – 605, 705, 6286,</b> 6386 <b>Epson – PC</b> <b>LYNK – 096, 196,187, Lite</b> <b>DELL – 210 PC</b> <b>MAI Basic IV- 1200,</b> 1400,1800	<b>IBM – 3180-1, 3191,</b> 3192, 3196,3197,3476,3477 <b>Telex/Memorex-</b> 191,197,1192, 1196,1197,1476  <b>* 122 Keyboards</b>	<b>IBM –</b> 3151,3161,3163,3179 -1,3180-1, 3191,3192,3196,3197 ,3471,3472,3476,347 7 <b>ATT –</b> 6500,6528,6529	<b>IBM – 3180-2,</b> 3179-2 <b>DEC DATA-</b> All Models	<b>ATT –</b> 610, 615

A	B	C	1 Keyboard Function	2 Keyboard Function	3 Keyboard Function	4 Keyboard Function	5 Keyboard Function
00	\$U	#00					
01	\$A	#01					
02	\$B	#02					
03	\$C	#03					
04	\$D	#04					
05	\$E	#05	Solicit Aux Port	Solicit Aux Port	Solicit Aux Port	Solicit Aux Port	Solicit Aux Port
06	\$F	#06					
07	\$G	#07		New Line	New Line		
08	\$H	#08					
09	\$I	#09					
0A	\$J	#10					
0B	\$K	#11	Tab Fwd	Tab Fwd	Tab Fwd	Tab Fwd	Tab Fwd
0C	\$L	#12	DEL	DEL	DEL	DEL	DEL
0D	\$M	#13	New Line	New Line	New Line	New Line	New Line
0E	\$N	#14	Insert	Insert	Insert	Insert	Insert
0F	\$O	#15			Clear		
10	\$P	#16		Error Reset	Error Reset		
11	\$Q	#17	Home	Home	Home	Home	Home
12	\$R	#18	Print		Print	Print	Print
13	\$S	#19	BackSpace	BackSpace	BackSpace	BackSpace	BackSpace
14	\$T	#20	BackField	BackField	BackField	BackField	BackField
15	4U	#21					
16	\$V	#22	F1	F1	CMD1	CMD1	CMD1
17	\$W	#23	F2	F2	CMD2	CMD2	CMD2
18	\$X	#24	F3	F3	CMD3	CMD3	CMD3
19	\$Y	#25	F4	F4	CMD4	CMD4	CMD4
1A	\$Z	#26	F5	F5	CMD5	CMD5	CMD5
1B	%A	#27	F6	F6	CMD6	CMD6	CMD6
1C	%B	#28	F7	F7	CMD7	CMD7	CMD7
1D	%C	#29	F8	F8	CMD8	CMD8	CMD8
1E	%D	#30	F9	F9	CMD9	CMD9	CMD9
1F	%E	#31	F10	F10	CMD10	CMD10	CMD10

## Keyboard Functions Supported

**A = Hex Code**

**B = Keyboard Function Code**

**C = Keyboard Function Record**

Column 6	Column 7	Column 8	Column 9	Column 10
TELEX – 078, 079, 080, 179,180, 191	HP – 700/92	ATT – 4410, 4425, 715 ADDS – 1010	Data General – D214, D215, D412 UNISYS- T27	UNISYS – B26

A	B	C	6 Keyboard Function	7 Keyboard Function	8 Keyboard Function	9 Keyboard Function	10 Keyboard Function
00	\$U	#00					
01	\$A	#01	Enter	Enter	Enter	Enter	Enter
02	\$B	#02					Next Page
03	\$C	#03					Prev Page
04	\$D	#04					Mark
05	\$E	#05	Solicit Aux Port	Solicit Aux Port	Solicit Aux Port	Solicit Aux Port	Solicit Aux Port
06	\$F	#06					Bound
07	\$G	#07	New Line	Carriage Rtn	Return	New Line	New Line
08	\$H	#08	Field Exit	Back Space	Back Space		Next
09	\$I	#09	Field +	Tab Fwd	Tab Fwd	Tab Fwd	Tab Fwd
0A	\$J	#10	Field -		Line Feed	New Line	Cancel
0B	\$K	#11	Field Fwd		Num Lock		Move
0C	\$L	#12	DEL	DEL	DEL	DEL	DEL
0D	\$M	#13	New Line	Carriage Rtn	Return	New Line	New Line
0E	\$N	#14	Insert	Insert		Erase EOL	Over Type
0F	\$O	#15	Clear	Erase Screen	Erase Screen	Erase Page	Copy
10	\$P	#16	Error Reset	Error Reset		Print	Finish
11	\$Q	#17		Home	Home	Home	Action
12	\$R	#18	Print	Delete Line	Up Arrow	Up Arrow	Up Arrow
13	\$S	#19	Back Space	Erase & Page	Left Arrow	Left Arrow	Left Arrow
14	\$T	#20	Back Field	Erase & Line	Down Arrow	Down Arrow	Down Arrow
15	4U	#21		Insert Line	Right Arrow	Right Arrow	Right Arrow
16	\$V	#22	CMD1	F1	F1	F1	F1
17	\$W	#23	CMD2	F2	F2	F2	F2
18	\$X	#24	CMD3	F3	F3	F3	F3
19	\$Y	#25	CMD4	F4	F4	F4	F4
1A	\$Z	#26	CMD5	F5	F5	F5	F5
1B	%A	#27	CMD6	F6	F6	F6	F6
1C	%B	#28	CMD7	F7	F7	F7	F7
1D	%C	#29	CMD8	F8	F8	F8	F8
1E	%D	#30	CMD9	F9	F9	F9	F9
1F	%E	#31	CMD10	F10	F10	F10	F10

## Keyboard Functions Supported

**A = Hex Code**

**B = Keyboard Function Code**

**C = Keyboard Function Record**

Column 11	Column 12
WYSE – ASCII Keybd DEC - 220	WYSE – PC Enhanced

A	B	C	11 Keyboard Function	12 Keyboard Function
00	\$U	#00		
01	\$A	#01	Enter	Enter
02	\$B	#02	PF1	Caps Lock
03	\$C	#03	PF2	
04	\$D	#04	PF3	
05	\$E	#05	Solicit Aux Port	Solicit Aux Port
06	\$F	#06	Break – Wyse 85	
07	\$G	#07	New Line	Up Arrow
08	\$H	#08	PF4	Left Arrow
09	\$I	#09	Tab Fwd	Down Arrow
0A	\$J	#10		Right Arrow
0B	\$K	#11		Tab Fwd
0C	\$L	#12	Remove	DEL
0D	\$M	#13	New Line	Enter- RT Kybd
0E	\$N	#14	Insert Here	Insert
0F	\$O	#15	Up Arrow	F11
10	\$P	#16	Left Arrow	F12
11	\$Q	#17	Down Arrow	Home
12	\$R	#18	Right Arrow	Print
13	\$S	#19	Back Space	Back Space
14	\$T	#20	Print Screen	Back Tab
15	4U	#21		
16	\$V	#22	F1	F1
17	\$W	#23	F2	F2
18	\$X	#24	F3	F3
19	\$Y	#25	F4	F4
1A	\$Z	#26	F5	F5
1B	%A	#27	F6	F6
1C	%B	#28	F7	F7
1D	%C	#29	F8	F8
1E	%D	#30	F9	F9
1F	%E	#31	F10	F10

## Keyboard Functions Supported

A = Hex Code

B = Keyboard Function Code

C = Keyboard Function Record

A	B	C
00	\$U	#00
01	\$A	#01
02	\$B	#02
03	\$C	#03
04	\$D	#04
05	\$E	#05
06	\$F	#06
07	\$G	#07
08	\$H	#08
09	\$I	#09
0A	\$J	#10
0B	\$K	#11
0C	\$L	#12
0D	\$M	#13
0E	\$N	#14
0F	\$O	#15
10	\$P	#16
11	\$Q	#17
12	\$R	#18
13	\$S	#19
14	\$T	#20
15	4U	#21
16	\$V	#22
17	\$W	#23
18	\$X	#24
19	\$Y	#25
1A	\$Z	#26
1B	%A	#27
1C	%B	#28
1D	%C	#29
1E	%D	#30
1F	%E	#31

IBM 3653 – 30 Key

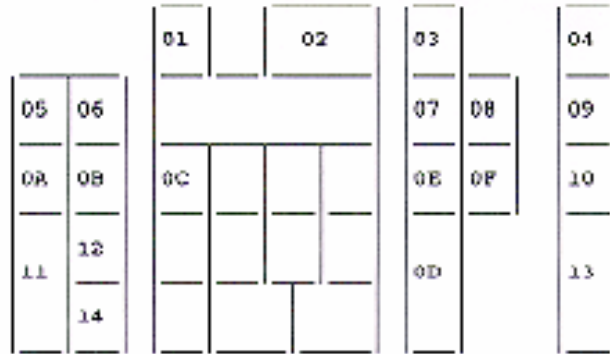

IBM 3653 – 48 Key

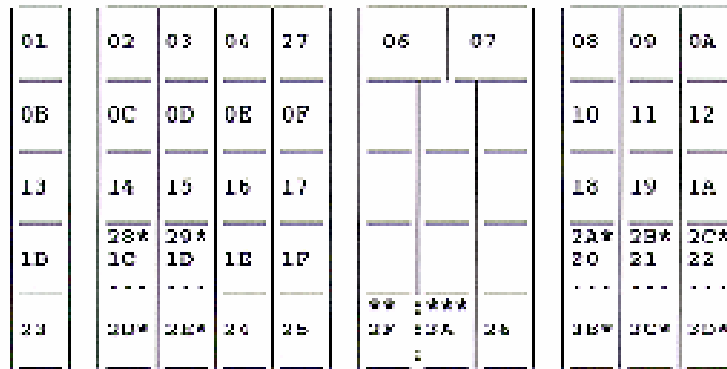

- \* Denotes ASCII Function Code to be used when Single Position Key Cap is Used.
- \*\* If this single key is used as the single digit zero, switch parameter 2 must be on
- \*\*\* If this single key is used as the single digit zero, switch parameter 2 must be on

## Keyboard Functions Supported

A = Hex Code

B = Keyboard Function Code

C = Keyboard Function Record

A	B	C
00	\$U	#00
01	\$A	#01
02	\$B	#02
03	\$C	#03
04	\$D	#04
05	\$E	#05
06	\$F	#06
07	\$G	#07
08	\$H	#08
09	\$I	#09
0A	\$J	#10
0B	\$K	#11
0C	\$L	#12
0D	\$M	#13
0E	\$N	#14
0F	\$O	#15
10	\$P	#16
11	\$Q	#17
12	\$R	#18
13	\$S	#19
14	\$T	#20
15	4U	#21
16	\$V	#22
17	\$W	#23
18	\$X	#24
19	\$Y	#25
1A	\$Z	#26
1B	%A	#27
1C	%B	#28
1D	%C	#29
1E	%D	#30
1F	%E	#31

### IBM 3653 – 35 Key

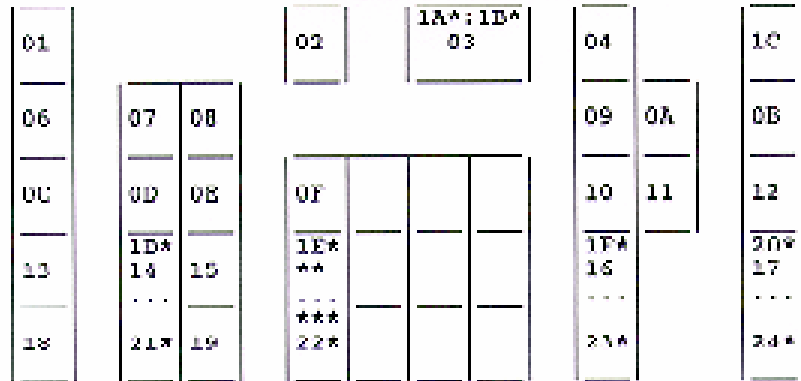

- \* Denotes ASCII Function Code to be used when Single Position Key Cap is Used.
- \*\* If this single key is used as the single digit zero, switch parameter 2 must be on
- \*\*\* If this single key is used as the single digit zero, switch parameter 2 must be on

### NCR 2151 & 2152

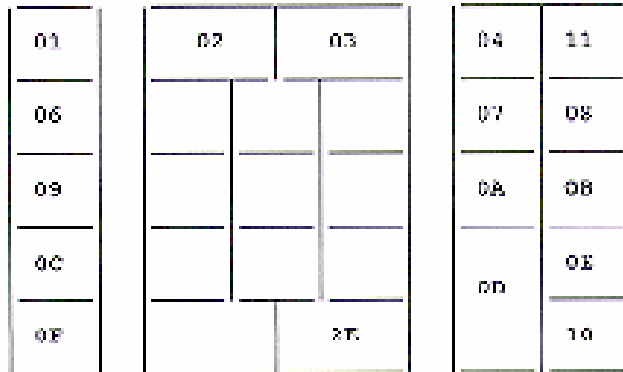

## Keyboard Functions Supported

A = Hex Code

B = Keyboard Function Code

C = Keyboard Function Record

A	B	C
00	\$U	#00
01	\$A	#01
02	\$B	#02
03	\$C	#03
04	\$D	#04
05	\$E	#05
06	\$F	#06
07	\$G	#07
08	\$H	#08
09	\$I	#09
0A	\$J	#10
0B	\$K	#11
0C	\$L	#12
0D	\$M	#13
0E	\$N	#14
0F	\$O	#15
10	\$P	#16
11	\$Q	#17
12	\$R	#18
13	\$S	#19
14	\$T	#20
15	4U	#21
16	\$V	#22
17	\$W	#23
18	\$X	#24
19	\$Y	#25
1A	\$Z	#26
1B	%A	#27
1C	%B	#28
1D	%C	#29
1E	%D	#30
1F	%E	#31

### NCR 2154 & 2155

01	02	03	04	29	06	07	08
09	0A	0B	0C	0E	0F	10	11
12	13	14	17	30	32	15	16
18	19	1A	34	35	36	19	17
1D	1E	1F	31	32	33	00	1B
23	24	25	30	26	20	21	22
						27	28

### NCR 2151 & 2152

01	02	03	04
05			06
07			08
09			
			0A

## Keyboard Functions Supported

A = Hex Code

B = Keyboard Function Code

C = Keyboard Function Record

A	B	C
00	\$U	#00
01	\$A	#01
02	\$B	#02
03	\$C	#03
04	\$D	#04
05	\$E	#05
06	\$F	#06
07	\$G	#07
08	\$H	#08
09	\$I	#09
0A	\$J	#10
0B	\$K	#11
0C	\$L	#12
0D	\$M	#13
0E	\$N	#14
0F	\$O	#15
10	\$P	#16
11	\$Q	#17
12	\$R	#18
13	\$S	#19
14	\$T	#20
15	4U	#21
16	\$V	#22
17	\$W	#23
18	\$X	#24
19	\$Y	#25
1A	\$Z	#26
1B	%A	#27
1C	%B	#28
1D	%C	#29
1E	%D	#30
1F	%E	#31

### NCR 2154 & 2155

61	62	63	64	65	66	67
68	69	6A	6B	6C	6D	6E
6F	70	71	72	73	74	75
16	17	07	09	11	01*	76
18	19*			10*	15	77*
1A*	1B			0F	14*	78
1C	1D*			0E*	13	79*
1E*	1F	0A*	0C	0D	12*	7A

### NCR 2151 & 2152

3X	31	40	23	24	25	46	26	2A	2R	29	5P	2A	08
60	31	32	33	34	35	36	37	38	39	30	2D	3D	09
0B	51	57	45	52	54	55	49	4F	50	70	7D	7C	5C
	61	73	64	66	67	68	6A	6B	6C	3A	22	0D	
	5A	5D	43	56	42	48	4D	3C	38	3F			
	7A	7B	63	76	62	6E	6D	2C	2E	2F			

NCR 7052 - CONTROL KEYPAD

						7P	02	03
						7R	04	05

NCR 7052 - POS KEYPAD

1A	17	07	09	11	01*
18	19*			13*	15
1A*	1B			0F	14*
1C	1D*			0E*	13
1E*	1F	0A*	0C	0D	12*

### \* Denote Blocking Keys –

If the Blocking Keys are used with a double key cap in association with another key, the key corresponding to the “\*” Function Codes must not be used.



**Appendix E: RS 232 AUXILIARY PORT  
- TECHNICAL SPECIFICATIONS**

This appendix provides information for connecting devices to the RS 232 Auxiliary Port of the unit.

The port receptacle will receive an AMP - [RJ] plug: Defined as a 8 position, 8 contact connector.

The RS 232 Auxiliary Port can support ASCII, Asynchronous, Serial communications.

The RS 232 Auxiliary Port provides an external serial interface with the following communications port (pin out) definitions:

1 = RTS request to send line	Input
2 = TXD transmit data line	Output
3 = CTS clear to send line	Output
6 = GND ground line	
8 = RXD receive data line	Input

The RS 232 Auxiliary Port is programmed with the following capabilities and constraints.

- A data record (label) can start with any ASCII data.
- A data record can include any data in the ASCII character set 00h thru 7Fh. The unit will delete characters not included in this character set from the incoming data record.
- A data record must end with a Record Terminator.  
**NOTE:** The record terminator selected will **NOT** be transmitted to the terminal. Its only function is to signal the end of a record.
- A data record (label) can contain or consist of one or more keyboard record function codes. Keyboard function codes can be embedded in any position within the data record.
- If Keyboard Functions are being sent to the terminal, the parameter "Functions Codes" for the Serial Port must be enabled.
- A Preamble or Postamble may be attached to the record being uploaded.
- An edit can be programmed for the RS 232 input record to both validate and reformat the data prior to output transmission. See Appendix C for further information about key codes.
- Record length can not exceed 64 characters.

## Appendix F: RS 232 INPUT - DATA TRANSFER DEFINITIONS

The protocol selections are designed to accommodate two basic forms of data transfer - Record and Automatic/Operator Controlled Upload.

- **PROTOCOL = RECORD**

The first data transfer method is termed Record Protocol. This protocol is used when scales or other readers are connected to the auxiliary port. These devices send data in a record format. The data is buffered by the unit until the End of Record is received. Once received, the data record will be transmitted to the terminal.

If Input Inhibit is NOT being checked, the operator must take responsibility for pacing the input to make sure that the terminal is available for data entry. This is true for all protocol options.

See Appendix A: "Interfaces" for terminals that support Input Inhibit, and Appendix G: "Input Inhibit Considerations" for the installation of the Input Inhibit cable when necessary .

1.     ***TRANSFER METHOD =            RECORD***  
       ***PROTOCOL =                    READY***

Terminals Supported:    ALL  
Maximum Record Size:   64  
Record Terminator:     Programmed (00H-7FH)

**NOTE:**

The Record Terminator is only used to signal the end of data. Data will not be transmitted to the screen until the Record Terminator is received. The Record Terminator itself will not be transmitted to the screen. If Keyboard Functions are being sent to the terminal, the parameter "Function Codes" for the Serial Port must be enabled.

A Preamble, Postamble or an Edit can be programmed for the RS 232 input record to both validate and reformat the data prior to output transmission.

2.     ***TRANSFER METHOD =            AUTOMATIC/OPERATOR***  
       ***CONTROLLED UPLOAD***

The second type of data transfer is covered by the remaining protocols (Solicit, Burst, ACK) These are used for uploading data from portable devices.

For a automatic upload Input Inhibit MUST be checked and the portable must be able to recognize a DC1 for Solicit or a DC1/DC3 for Burst. Another possibility is if the portable can be controlled by the CTS line in Burst.

If Input Inhibit is NOT being checked, each block of data must be transmitted by an Operator Controlled Operation on the portable.

For further information on Input Inhibit, reference Appendix A: "Interfaces" and Appendix G: "Input Inhibit Considerations".

The Serial Port Preamble and Postamble are used to aid in the control of the data being uploaded.

**Preamble:**

If defined a Start of Block Character **MUST** be sent before any data buffering will take place. The character defined will be expected for each block.

**Postamble:**

Three positions can be defined.

**Position 1: Record Postamble**

If defined, the character will be appended to the end of each record. An entry of "00" (Zero, Zero) will Null any position.

**Position 2: End of Block Character**

Default = "ETX" (03h)

**Position 3:** Determines whether the **transmit command** will be issued at the end of a block.

Default = "Y" (59)

3. **TRANSFER METHOD = AUTOMATIC UPLOAD**  
**PROTOCOL = XON**

Terminals Supported: Only those that support Input Inhibit checking. Check Appendix A: "Interfaces".

The connecting unit must be able to respond to a "DC1" (i.e. XON).

Device controlled block size. Data records must be sent in a fixed record count, separated by a end of record character. The blocking factor cannot exceed the limitation of the terminal screen it is being sent to (Maximum characters per block = 1500).

Each block of data must be terminated by a End-of-Text (ETX = 03h) character.

To signal the transmission of the last block of data from the device, the last block of data is terminated by End-Of-Transmission (EOT), End-Of-Text (ETX). Or, a block of data can be sent containing just the End-Of-Transmission (EOT) character.

After the first block of data is received the unit will solicit the subsequent blocks by sending a DC1 (11h) to the device. The device must wait for the DC1 before sending any subsequent blocks.

Upon receiving the End-Of-Text (ETX) the unit will automatically transmit the block to the terminal, "Screen", and issue "ENTER" to transmit to the host CPU before it solicits the next block of data.

If Keyboard Functions are being sent to the terminal, the parameter Functions Codes for the Serial Port must be enabled.

See Page F-2 for Postamble and Preamble definitions.

## Sequence of Events For Portable Device Automatic Upload to a Terminal

### Portable

### Wedge

Operator sends 1 <sup>st</sup> block of data (ETX) or Portable responds to DC1	◀ Sends DC1 until data is received
Device Sends Block 2 (ETX)	▶ Sends Block 1 to the terminal ◀ Sends DC1 until data is received
Device Sends Block n (ETX) or (ETX)	▶ Sends Block 2 to the Terminal ◀ Sends DC1 until data is received
Device sends (EOT) or nothing if (EOT) Device Was sent with Block n	▶ Sends Block n to the Terminal ◀ Sends DC1 ▶ Ends communication with the Portable  by audible alerts to the operator of upload completion.

**4.      *TRANSFER METHOD =                      OPERATOR CONTROLLED UPLOAD***  
***PROTOCOL =                                SOLICIT***

Terminals Supported: ALL

During the transmission of data to the terminal the operator will monitor the terminal for input inhibit restriction. By doing so, no data should be lost.

All blocks of data sent must be initiated by the operator. Therefore, the connecting unit must be able to respond to an operator command entered on it.

Device controlled block size. Data records must be sent in a fixed record count, separated by an end-of-record character. The blocking factor cannot exceed the limitation of the defined terminal screen.

Each block of data must be terminated by a End-Of-Text (ETX = 03h) character.

To signal the transmission of the last block of data from the device, the last block of data is terminated by End-Of-Transmission (EOT), End-Of-Text. Or, a block of data can be sent containing just the End-Of-Transmission (EOT) character.

Upon receiving the Record Terminator the unit will automatically transmit the block to the terminal "Screen", and issue "ENTER" to transmit to the host CPU before it solicits the next block of data.

If Keyboard Functions are being sent to the terminal, the parameter Functions Codes for the Auxiliary Port must be enabled.

See Page F-2 for Postamble and Preamble definitions.

## Sequence of Events for Portable Device Using Operator Controlled Upload to a Terminal

### Portable

### Wedge

<p>Portable Ignores DC1 Operator Sends 1st Block of Data (ETX)</p> <p>Portable Ignores DC1 Operator Sends Block 2 (ETX)</p> <p>Portable Ignores DC1 Operator Sends Block n (ETX) or (EOT ETX)</p> <p>Portable Ignores DC1 Operator Sends (EOT) or nothing if (EOT) was sent with Block n</p>	<p>◀</p> <p>▶</p> <p>◀</p> <p>▶</p> <p>◀</p> <p>▶</p> <p>◀</p> <p>▶</p>	<p>Sends DC1 until data is received</p> <p>Sends Block 1 to the terminal Sends DC1 until data is received</p> <p>Sends Block 2 to the Terminal Sends DC1 until data is received</p> <p>Sends Block n to the Terminal Sends DC1 Ends communications with the Portable Device by audible alerts to the operator of upload completion.</p>
--	---	---

**5.     *TRANSFER METHOD =            AUTOMATIC UPLOAD***  
***PROTOCOL =                    BURST***

Terminals Supported: Only those that support Input Inhibit checking. Check Appendix A: "Interfaces". During the transmission of data to the terminal the unit will monitor the terminal for input inhibit restriction. By doing so, no data will be lost in the event that the terminal is inhibited.

The connecting unit must be able to respond to a "DC1" and "DC3" (i.e. XON, XOFF), and to the raising and lowering of the "Clear To Send" (CTS) line.

The wedge controls the size of the block being sent to the terminal. Once 1500 characters have been received the wedge will issue a XOFF and drop CTS. The first block of data sent must be initiated by the operator. After the first block of data is received the wedge will control the flow of subsequent blocks. Upon receiving the 1500 characters the wedge will:

- 1) issue an XOFF and drop CTS
- 2) automatically transmit the block of data to the terminal "Screen"
- 3) automatically transmit to the host CPU
- 4) Raise Clear-To-Send (CTS)
- 5) Issue an XON for the next burst of data

The last block of data is terminated by End-Of-Transmission (EOT).

If Keyboard Functions are being sent to the terminal, the parameter Functions Codes for the Auxiliary Port must be enabled.

See Page F-2 for Postamble and Preamble definitions.

**NOTE:**

It is recommended that when sending data in this mode, that an Intercharacter Delay be set in the portable device to insure that the device does not "miss" any XOFF instructions before sending any data. This will help to prevent any loss of data on a character-to-character transmit basis.

**6.      *TRANSFER METHOD =            RECORD***  
***PROTOCOL =                    ACK***

When programmed for ACK protocol, the unit will receive data in two transfer modes. One will be Single Records, the other a block type mode consisting of multiple records. The controlling parameters will be the Auxiliary Port Preamble and Postamble selections.

***Preamble:***        Defines the Start of Block Character.  
                      No data will be buffered until the Preamble is received. Default (not defined) = NO  
                      Start of Block Character will be expected.

***Postamble:***        Three positions for controlling data.  
                      **1** = A Postamble to be appended to the end of each record.  
                      **2** = Character that defines the end of block. If not assigned a value, Record Mode is active (each record represents a block).  
                      **3** = Enter the character "Y" (Yes) or "N" (No) to indicate if the Enter/Transmit command is to be sent at the end of each block.

With the Record Mode active, the unit receives data in single records. A record may contain up to 1500 bytes, including the Record terminator. After receipt, the record will be transmitted to the terminal, and an ACK (06h) will be sent to the connected device. The device is now allowed to send another record.

The use of the Second Postamble Character, activates ACK Block Mode. Whereby, an ACK (06h) is sent to the connected device after each record is received. The records are buffered until the defined postamble code is received. This code is NOT ACKed. The records stored will be transmitted to the terminal and an "Enter" will be issued at the end of block. An ACK will then be sent to the connected device. The device can then begin another transfer.

The standard programming rules are in effect for all other parameters.

**Sequence of Events for Portable Device Upload Using Record Mode - ACK Protocol**

<b>TERMINAL</b>	<b>WEDGE</b>	<b>RS 232 CONNECTED DEVICE</b>
		◀ 1st Rec. (EOR) device initiates transmission
	◀ Receives and buffers record. Sends Rec. to Terminal. If 1 <sup>st</sup> character of Postamble is defined, it is transmitted.	
	Sends ACK (06h) *	▶ After receiving ACK, the device may transmit next record (if any)
		◀ Device sends nth Rec. (EOR) (if any)

Loop back to Step 2.

This sequence is repeated until all records are sent from connected device.

**Sequence of Events for Portable Device Upload Using Block Mode ACK Protocol**

<b>TERMINAL</b>	<b>WEDGE</b>	<b>RS 232 CONNECTED DEVICE</b>
		◀ 1st Rec. (EOR) device initiates transmission
	Receives and buffers record. Sends ACK (06h)	▶ ACK is received.
	Repeat ACK (06h) for each record until the End of Block (EOB) character is received.	◀ Device transmits next record. ◀ Device sends nth Rec. (EOR)
	Receives Record and/or (EOB)	◀ Device sends Record, (EOR), (EOB) or (EOB) by itself
◀	All stored records are transmitted to the terminal, at the end of the block a "Enter" command will be sent to the terminal. (See Postamble).	
	Sends ACK to the device to signal it to begin transmitting again.	▶

Loop back to Step 4

## Appendix G: INPUT INHIBIT CONSIDERATIONS

The following pages describe the operation of the unit relevant to each terminal type supporting "Input-Inhibit", which when monitored will prevent the loss of data from the unit to the terminal and in turn to the host CPU. In most terminal environments, the terminal is often "inhibited" from sending data to the host CPU. This can happen just after a screen, or "page" of data is sent to the host CPU by the operator activating the "XMIT", "REC ADV", or "ENTER" key at the keyboard. Further input from the keyboard is ignored by the terminal, as long as input is inhibited by the host CPU. The Input-Inhibited condition is usually indicated to the operator by a visual indicator on the terminal screen.

Because the unit emulates the operator's action of sending data to the host CPU and in turn cause an input-inhibited condition, this condition must be monitored by some means other than a visual indicator. Described on the following pages are some operator "rules" and hardware installation procedures required for each terminal supported.

Input-inhibited monitoring is accomplished only if the unit has been programmed to do so. Refer to the "GENERAL I" programming menu for programming Input Inhibit.

Unless the terminal type is specified in this appendix, the unit will **NOT** monitor Input Inhibit regardless of how the parameter is set.

### **DECISION DATA: 3761, 3791**

The unit will monitor Input Inhibit if the unit has been programmed for this parameter to be ON and the ENTER command is issued.

**IBM :** 3179-1  
**TELEX:** 078, 079, 080, 179, 180, 191

After power, the Input Inhibit parameter must be selected. Also, the keyboard clicker "on/off" key can not be used by the operator.

However, if Input Inhibit is not being monitored, this clicker key is available to the operator.

### **IBM: 3180-1, 3180-2**

If Input Inhibited is to be monitored, the Intercharacter Delay parameter must be set to 02 and a jumper cable must be installed inside the terminal. The following sequence describes the installation.

1. Remove the logic element from the IBM 3180. Move the lever on the lower-left, rear corner of the terminal to the "OPEN" position. Push the two locking bars at the right side of the logic element forward. Hold the logic element and swing the right side out. Remove the two left latches from the display element.
2. View the logic element with the PC board face up. Attach the spring clip end of the single wire cable (ordered with the standard interface cable) to the right terminal of the speaker.
3. Thread the unattached end of the single wire cable through one of the slots at the bottom of the logic element, making certain that the cable will not interfere with the reinstallation of the logic element.
4. Install the logic element on the display element.



5. Connect the single wire receptacle, from the bottom of the element, to the single wire plug from the terminal end of the interface cable ordered with the unit.

**NOTE:**

You must disconnect the single wire cable at the plug and receptacle junction if the unit is removed from the IBM 3180 terminal, but need not remove it from the logic element.

6. The operator must turn the keyboard clicker on and the clicker volume to a medium to high level (refer to the IBM 3180 users manual "set-up" procedures).
7. The hardware installation to monitor Input-Inhibit is now complete.

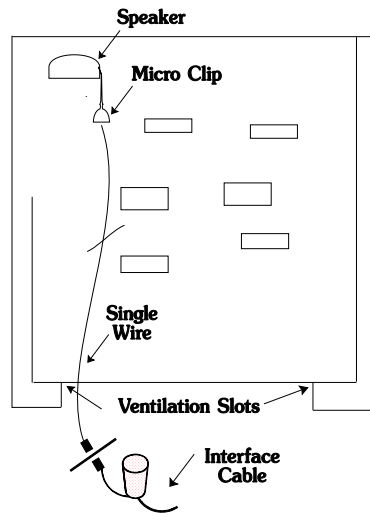

**IBM 3180: Input Inhibit Installation**

**IBM: 3179-2**

If Input Inhibited is to be monitored, a jumper cable must be installed inside the terminal. The following sequence describes the installation.

1. Remove the logic element from the IBM 3179-2. Refer to the IBM 3179 Model 2 Problem Solving Guide, Steps 1 through 7 of "Logic Element Removal" procedures.
2. Open the logic element by removing the hex head screw from the bottom center of the logic element case. Next push in the tabs at the front of the case and lift the top from the logic element case.
3. View the logic element with the PC board face up. Attach the "spring clip" end of the single wire cable (ordered with the standard interface cable) to pin 9 on the chip at board location ZM22. Pin 9 is the sixth pin from the top (notched end) of the chip on the right side.
4. Thread the unattached end of the single wire cable through the hole at the back of the logic element, next to the monitor connector, making certain that the cable will not interfere with the reinstallation of the logic element.
5. Install the logic element on the display element.

6. Connect the single wire receptacle, from the back of the logic element, to the single wire plug, from the terminal end of the interface cable, ordered with the unit.

**NOTE:**

You must disconnect the single wire cable at the plug and receptacle junction if the unit is removed from the IBM 3179-2 terminal, but need not remove it from the logic element.

7. The operator must turn the keyboard clicker on and the clicker volume should be set to a mid to hi level. Refer to the IBM 3179-2 users manual "set-up" procedures.
8. The hardware installation to monitor Input-Inhibit is now complete.

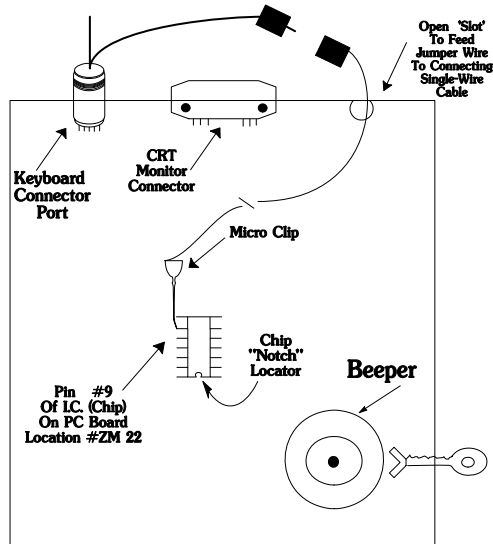

**IBM 3179-2: Input Inhibit Installation**

**IBM: 3196**

If input inhibited is to be monitored, a jumper cable must be installed inside the terminal. The following sequence describes the installation.

1. Remove the logic element from the IBM 3196. Refer to IBM 3196 Display Problem Solving Guide, "logic Element Removal" section.
2. Open the logic element by pressing a flathead screw driver in the 4 slots at the corners on the bottom of the logic element.
3. View the logic element with the PC Board face-up and the front of the logic element facing you. Attach the spring clip end of the single wire cable (ordered with the standard interface cable) to pin 1 on the clip at board location U-7. Pin 1 is the first pin from the notched end of the chip on the right side.
4. Thread the unattached end of the single wire cable through one of the grid holes at the bottom of the logic element near the front of the unit, making certain that the cable will not interfere with the installation of the logic element.

5. Place the logic element cover back on and install the display on the logic element by following the "logic element replacement" procedures on the IBM 3196 Display Station Problem Solving Guide.
6. Connect the single wire receptacles from the front of the logic element to the single wire plug, from the terminal end of the interface cable, ordered with the unit.

**NOTE:**

You must disconnect the single wire cable at the plug and receptacle junction if the unit is removed from the IBM 3196 terminal, but need not remove it from the logic element.

7. The operator must turn on the keyboard clicker and set the clicker volume at levels 2, 3, or 5. To determine the clicker volume level, refer to IBM 3196 manual on clicker volume set-up. We refer to no clicker volume as level 0. Each time you press the F5 key to increase volume, it is increased by 1. The highest clicker volume would be level 5.
8. The hardware installation to monitor input-inhibit is now complete.

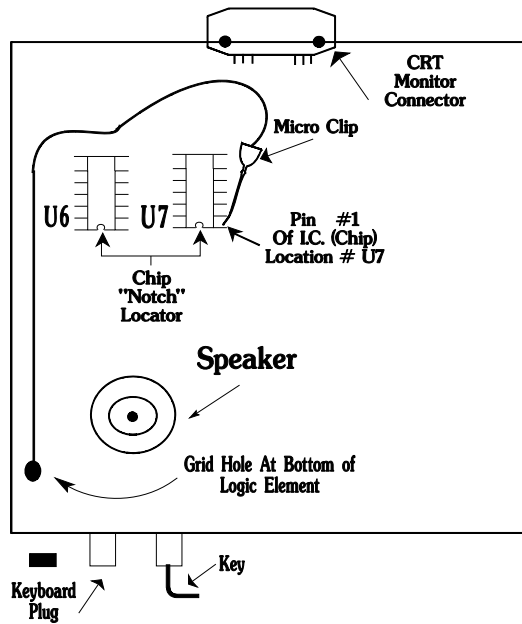

**IBM 3196: Input Inhibit Installation**

**IBM: 3481, 3486**

If Input Inhibited is to be monitored, a jumper cable must be installed inside the terminal.

After this cable is installed, Input Inhibit can be monitored only if the unit is programmed for this function.

The following sequence describes the installation.

1. Insure that the IBM 3481/3486 terminal is powered off and the AC power is disconnected.
2. Extract the monitor from the cabinet by removing the 2 torque type screws from the bottom of the unit. Insert a long, flat instrument (ideally with a point) int the 2 small slots on the top-back of the cabinet. Using a slight amount of pressure, pry the internal catches downward and pull back on the cabinet.

3. After reviewing the following drawing, locate Transistor Q503 on the PC Board. Attach the single wire cable (ordered with the standard interface cable) spring clip end to the base leg of this transistor. (the leg opposite the one labeled on the PC board with an "E"). Reference Drawing.
4. Thread the single wire cable between the PC Board and the plastic shield located along the right hand side of the PC Board.
5. Re-Install the cabinet and thread the single wire cable through one of the air vents on the side of the cabinet.
6. Attach the single wire receptacle to the wire plug protruding from the interface cable (8 pin plug) that attaches to the terminal.
7. Complete the installation of the reader by programming the following:
 

3481 & 3486	Input Inhibit = <b>ON</b>
3486 Only	Intercharacter Delay = <b>02</b>
8. The IBM 3481/3486 must be configured with the following parameters set using the ON-Line Set-up.
 

Clicker =	OFF (3481)	ON (3486)
Volume =	1-4 (3481 & 3486)	
1. The hardware installation to monitor Input-Inhibit is now complete.

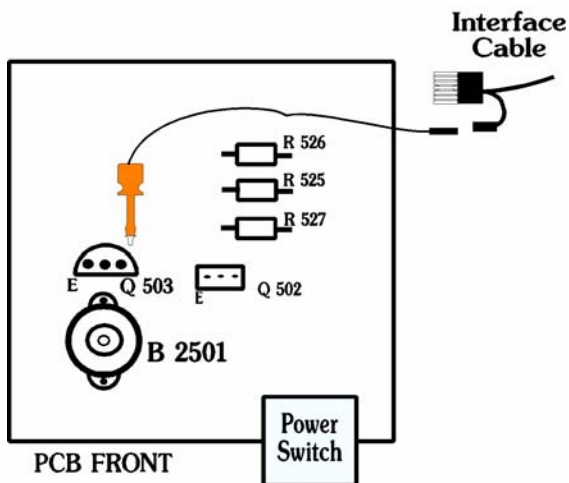

**IBM 3481& 3486: Input Inhibit Installation**

## **Appendix H: SERVICE AND REPAIR**

The unit carries a 1 year warranty. The specific warranty language is contained in the Appendix I of this manual.

Factory service is also available on a time and material basis for out-of-warranty products. If you use this mode of service you will be advised of a not-to-exceed price for repair when you request a Return Material Authorization (RMA) for the product.

Products may be returned for repair by requesting a Return Material Authorization (RMA) from Compsee Customer Service.

**1-321-724-4321 or 1-800-628-3888**

When calling Compsee Customer Service you should be prepared with the following information.

- Model Number
- Serial Number
- Accurate Description of the Problem
- Company Name (Being Sent From)
- When and How it is being Sent)
- Return to Address
- Contact Name and Telephone Number

This information is necessary for us to complete an RMA for the product. **We cannot accept materials that are returned without an RMA number.** This number will insure that the problem described is corrected and the unit is repaired and returned in a timely fashion.

Normal Repair time is 10 days from receipt of equipment.

Warranty Repairs: The user pays for the shipping of the equipment to Compsee. Compsee will pay for return shipping in the same manner that the equipment was shipped to Compsee, for warranty repairs.

Non-Warranty Repairs: The (user) will pay shipping both ways, to and from the service center.

**Appendix I: WARRANTY TERMS**

Compsee (**COMPSEE**) warrants that its products will be free of defects in workmanship and material for a period of one (1) year from the original shipment date when subject to normal use and service. This warranty does not cover any **COMPSEE** equipment which is

- (i) improperly installed or used
- (ii) damaged by accident or neglect, including failure to follow the proper maintenance, service and cleaning schedule
- (iii) damaged as a result of
  - (A) modification or alteration by the purchaser
  - (B) excessive voltage or current supplied to or drawn from the interface connections
  - (C) operation under conditions beyond the specified operating parameters
  - (D) repair or service of the equipment by anyone other than **COMPSEE** or its authorized representatives.

In the event of failure of equipment covered by this warranty, **COMPSEE** will repair such equipment returned (at customer expense) to its factory at Mt. Gilead, North Carolina, USA, within 1 year of original shipment date, provided that inspection by **COMPSEE** or a **COMPSEE** Authorized Independent Service Facility determines to its satisfaction that the equipment was defective due to defects in materials or workmanship. **COMPSEE** may, at its option, replace the equipment or subassembly in lieu of repair. Defective equipment, returned within five years of the original shipment date, will be repaired or replaced without charge, except for return shipping to **COMPSEE**, unless the failure was caused by misuse, neglect, accident, abnormal operating conditions, improper modification or alteration of the equipment, or repair or service of the equipment by anyone other than **COMPSEE** or its authorized representatives, in which case the repairs will be billed at the material and labor rates prevailing at the time of repair. In such case, a not-to-exceed repair estimate will be submitted before work is started, if requested.

No products will be accepted by **COMPSEE** or its Authorized Service Facilities without a Return Materials Authorization, which may be obtained by contacting the factory. In the event that the defective product cannot be repaired or replaced within a reasonable period of time **COMPSEE**'s sole obligation under this warranty shall be to refund the price paid, less tax and transportation.

**LIMITATIONS**

**EXCEPT AS MAY BE OTHERWISE PROVIDED BY APPLICABLE LAW, THE FOREGOING WARRANTY IS IN LIEU OF ALL OTHER COVENANTS OR WARRANTIES, EITHER EXPRESSED OR IMPLIED, ORAL OR WRITTEN, INCLUDING WITHOUT LIMITATION, ANY IMPLIED WARRANTIES OF MERCHANTABILITY OR FITNESS FOR A PARTICULAR PURPOSE. SOME STATE, PROVINCES, OR COUNTRIES DO NOT ALLOW DISCLAIMERS OR LIMITATIONS OF IMPLIED WARRANTIES, SO THE ABOVE DISCLAIMER AND LIMITATION MAY NOT COMPLETELY APPLY TO YOU.**

**COMPSEE'S RESPONSIBILITY AND PURCHASER'S EXCLUSIVE REMEDY UNDER THIS WARRANTY IS LIMITED TO THE REPAIR OR REPLACEMENT OF THE DEFECTIVE PRODUCTS. ANY PROVISION HEREIN TO THE CONTRARY NOTWITHSTANDING, COMPSEE SHALL NOT BE LIABLE FOR INDIRECT, INCIDENTAL OR CONSEQUENTIAL DAMAGES, AND IN NO EVENT SHALL ANY LIABILITY OF COMPSEE ARISING IN CONNECTION WITH ANY PRODUCTS SOLD HEREUNDER (WHETHER SUCH LIABILITY ARISES FROM A CLAIM BASED ON CONTRACT, WARRANTY, TORT, OR OTHERWISE) EXCEED THE ACTUAL AMOUNT PAID TO COMPSEE FOR THE PRODUCTS. SUCH LIMITATIONS IN LIABILITY SHALL REMAIN IN FULL FORCE AND EFFECT EVEN WHEN COMPSEE MAY HAVE BEEN ADVISED OF THE POSSIBILITY OF SUCH INJURIES, LOSSES OR DAMAGES. SOME STATES ALLOW THE EXCLUSION OR LIMITATION OF INCIDENTAL OR CONSEQUENTIAL DAMAGES, SO THE ABOVE LIMITATION OR EXCLUSION MAY NOT APPLY TO YOU.**

**COMPSEE SHALL NOT BE HELD RESPONSIBLE OR LIABLE IN ANY WAY FOR THE FAILURE TO SELL OR DELIVER ANY PRODUCTS HEREUNDER DURING A PERIOD IN WHICH SUCH SALE AND DELIVERY ARE PREVENTED OR HINDERED BY ANY CAUSE BEYOND COMPSEE'S REASONABLE CONTROL.**

**COMPSEE IS NOT RESPONSIBLE FOR DAMAGE TO THE PRODUCT OR EQUIPMENT INCURRED DURING THE SHIPMENT. ANY CLAIMS FOR SHIPPING DAMAGE SHOULD BE MADE DIRECTLY TO THE CARRIER.**

**NO COMPSEE AGENT, EMPLOYEE, OR REPRESENTATIVE HAS THE AUTHORITY TO MAKE OR IMPLY ANY REPRESENTATION, PROMISE OR AGREEMENT WHICH IN ANY WAY VARIES THE TERMS OF THIS LIMITED WARRANTY.**

All of the provisions of this Limited Warranty are separate and severable, which means that if any provision is held valid and unenforceable, such determination shall not affect the validity or enforceability of the other provisions hereof.

**This Limited Warranty gives the purchaser specific legal rights and the purchaser may also have other rights which vary from state-to-state, province-to-province, or country-to-country.**